

PRODUCTOS DE ORDENACIÓN



Suministros Industriales del Tajo, S.A.

PRODUCTOS DE ORDENACIÓN **2**

ARRANGEMENT PRODUCTS

GAVETAS APILABLES
STACKABLE DRAWERS



36

GAVETA PLEGABLE APILABLE
STACKABLE FOLDING DRAWER



38

EURO-CAJAS PARA ALMACÉN Y TRANSPORTE
EURO BOX



40

EURO-CAJAS CON TAPA PARA ALMACÉN Y TRANSPORTE
EURO BOX WITH COVER

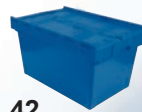

42

CAJONES ESTANTERÍAS
DRAWERS FOR SHELVES



43

SEPARADORES
DIVIDERS



43

KIT ESTANTERÍA METÁLICA
METAL SHELVES KIT



44

KIT ESTANTERÍA METÁLICA CON CAJONES
METAL SHELVES KIT WITH DRAWERS



45

KIT ESTANTERÍA PLÁSTICO
PLASTIC SHELVES KIT



46

KIT ESTANTERÍA PLÁSTICO CON CAJONES
PLASTIC SHELVES KIT WITH DRAWERS



47

MÓDULOS METÁLICOS
METAL STACKABLE MODULES



48

CONTENEDORES BASCULANTES
CABINET WITH TILTABLE DRAWERS



49

CONTENEDORES CAJONES
CABINETS WITH DRAWERS



50

ESTANTES CLASIFICADORES APILABLES
STACKABLE CLASSIFIERS SHELF UNIT



51

MÓDULOS APILABLES
STACKABLE MODULES



52

MÓDULOS BANDEJAS
TRAY MODULES



53

BIDONES CON CÁNULA (VERTEDERO)
JERRY CANS WITH SPOUT (FOR POURING)



54

BIDONES CON TAPÓN/GRIFO
JERRY CANS WITH CAP/TAP



55

BIDÓN METÁLICO CON CÁNULA (VERTEDERO)
METAL JERRY CANS WITH SPOUT (FOR POURING)



56

STASA

Suministros Industriales del Tajo, S.A.

Gavetas Apilables

Stackable Drawers

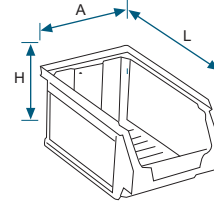
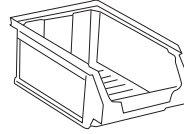
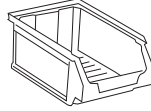
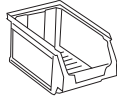

Modelo Model	51	52	53	54	55
Código Code	■ 251023 ■ 251108 □ 251344	■ 252020 ■ 252105 □ 252341	■ 253027 ■ 253102 □ 253348	■ 254024 ■ 254109 □ 254345	■ 255021 ■ 255106 □ 255342
Medidas Sizes	L A H 170x100x80 mm	L A H 236x160x130 mm	L A H 336x160x130 mm	L A H 336x216x155 mm	L A H 336x216x200 mm
Material	PP	PP	PP	PP	PP
Capacidad (Litros) Capacity (Liters)	0,8	3,2	4,8	7,7	10,1
Embalaje Packing	24 unid.	15 unid.	10 unid.	12 unid.	10 unid.
Medidas Embalaje Packing Sizes	336x214x345 mm	820x240x255 mm	840x350x194 mm	440x378x610 mm	1120x350x304 mm

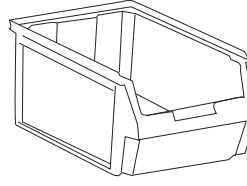
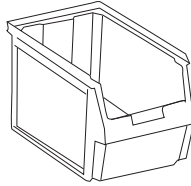
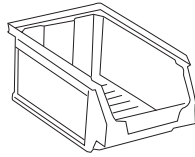
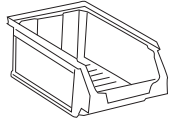

Modelo Model	56	58	59	60
Código Code	■ 256028 ■ 256103 □ 256349	■ 258022 ■ 258107 □ 258343	■ 259029 ■ 259104 □ 259340	■ 260025 ■ 260100 □ 260346
Medidas Sizes	L A H 420x270x175 mm	L A H 500x303x200 mm	L A H 500x303x300 mm	L A H 600x400x300 mm
Material	PP	PP	PP	PP
Capacidad (Litros) Capacity (Liters)	13,9	22,2	34	51,3
Embalaje Packing	8 unid.	12 unid.	6 unid.	6 unid.
Medidas Embalaje Packing Sizes	580x426x530 mm	954x512x590 mm	954x512x485 mm	804x598x600 mm



Modelo Model	7
Código Code	■ 207020
Medidas Sizes	L A H 170x160x80 mm
Material	PP
Capacidad (Litros) Capacity (Liters)	1,4
Color Colour	Azul Blue
Embalaje Packing	10 unid.
Medidas Embalaje Packing Sizes	327x174x365 mm



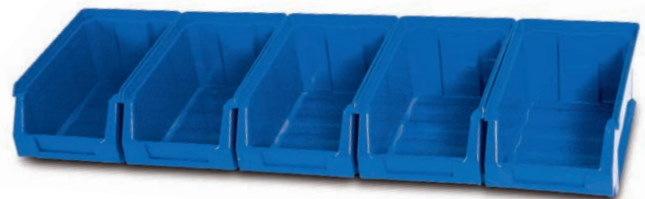

Modelo
Model Kit Colgar G-50

Código
Code 250903

Medidas
Sizes L A H
520x91x53 mm

Material
Gaveta PP/ Colgador PS
Drawer PP/ Hanger PS

Color
Colour Azul/Negro
Blue/Black

Contiene
Contained 5 Gavetas/ 1 Colgador
5 Drawers/ 1 Hanger

Embalaje
Packing 10 unid.

Medidas
Embalaje Packing Sizes 528x190x280 mm

Modelo
Model Kit Colgar G-51

Código
Code 251900

Medidas
Sizes L A H
520x170x80 mm

Material
Gaveta PP/ Colgador PS
Drawer PP/ Hanger PS

Color
Colour Azul/Negro
Blue/Black

Contiene
Contained 5 Gavetas/ 1 Colgador
5 Drawers/ 1 Hanger

Embalaje
Packing 10 unid.

Medidas
Embalaje Packing Sizes 528x340x398 mm

Gaveta Plegable Apilable

Stackable Folding Drawer



Gaveta Plegable Apilable

Stackable Folding Drawer



Modelo 52P
Model

Código ■ 202025
Code □ 202346

Medidas L A H
Sizes 236x160x130 mm

Material PP

Contiene 1 Kit = 5 gavetas flejadas
Contained 1 Kit = 5 strapped bin boxes

Embalaje 8 Kits = 40 unid.
Packing

Medidas 420x234x285 mm
Embalaje
Packing
Sizes

Gaveta Ref. 52* y Ref. 52P
Son apilables y compatibles

*Descripción en pág. 36



Modelo 53P*
Model

Código ■ 203022
Code □ 203343

Medidas L A H
Sizes 340x160x130 mm

Material PP

Contiene 1 Kit = 5 gavetas flejadas
Contained 1 Kit = 5 strapped bin boxes

Embalaje 8 Kits = 40 unid.
Packing

Medidas 420x345x332 mm
Embalaje
Packing
Sizes

Gaveta Ref. 53* y Ref. 53P
Son apilables y compatibles

*Descripción en pág. 36



APTO PARA USO ALIMENTARIO
Registro sanitario / Health registration
n° 3904321/V

Euro-Cajas para Almacén y Transporte

Euro Box

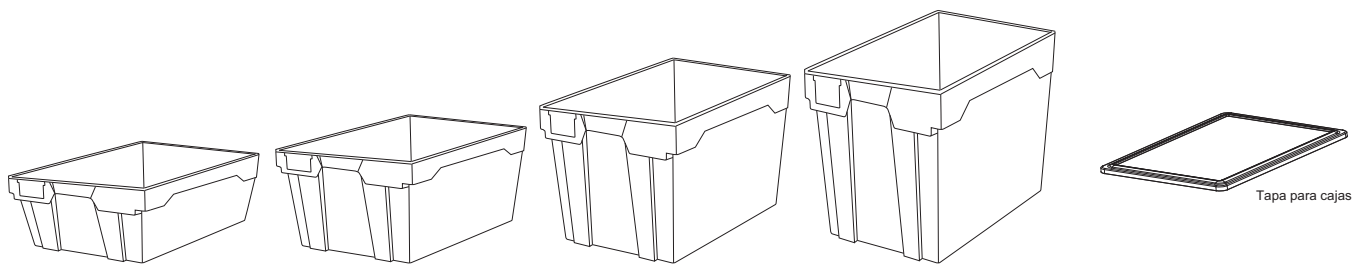

Modelo Model	6415	6420	6430	6440	6400
Código Code	261299	262296	263293	264290	299292
Medidas Sizes	600x400x150 mm	600x400x200 mm	600x400x300 mm	600x400x400 mm	605x405x29 mm
Capacidad (Litros) Capacity (Liters)	22 l.	34 l.	51 l.	69 l.	—
Peso (Kg.) Weight (Kg.)	1,23 Kg.	1,62 Kg.	2,16 Kg.	2,74 Kg.	0,65 Kg.
Material	PP	PP	PP	PP	PP
Color Colour	Natural Natural	Natural Natural	Natural Natural	Natural Natural	Natural Natural
Embalaje Packing	Retráctil 6 Palet 92	Retráctil 6 Palet 64	Retráctil 6 Palet 48	Retráctil 6 Palet 32	Retráctil 6
Medidas Embalaje Packing Sizes	Retráctil 600x400x360 mm Palet 1200x800x1224 mm	Retráctil 600x400x495 mm Palet 1200x800x1240 mm	Retráctil 600x400x645 mm Palet 1200x800x1215 mm	Retráctil 600x400x875 mm Palet 1200x800x1210 mm	Retráctil 605x405x120 mm



APTO PARA USO ALIMENTARIO
Registro sanitario / Health registration
n° 3904321/V

Euro-Cajas para Almacén y Transporte

Euro Box

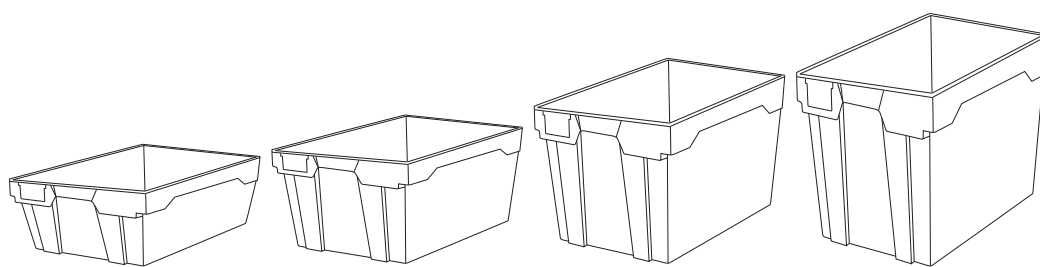

Tapa para cajas

Modelo Model	6415	6420	6430	6440	6400
Código Code	261008	262005	263002	264009	299001
Medidas Sizes	600x400x150 mm	600x400x200 mm	600x400x300 mm	600x400x400 mm	605x405x29 mm
Capacidad (Litros) Capacity (Liters)	22 l.	34 l.	51 l.	69 l.	—
Peso (Kg.) Weight (Kg.)	1,23 Kg.	1,62 Kg.	2,16 Kg.	2,74 Kg.	0,65 Kg.
Material	PP	PP	PP	PP	PP
Color Colour	Azul Blue	Azul Blue	Azul Blue	Azul Blue	Azul Blue
Embalaje Packing	Retráctil 6 Palet 92	Retráctil 6 Palet 64	Retráctil 6 Palet 48	Retráctil 6 Palet 32	Retráctil 6
Medidas Embalaje Packing Sizes	Retráctil 600x400x360 mm Palet 1200x800x1224 mm	Retráctil 600x400x495 mm Palet 1200x800x1240 mm	Retráctil 600x400x645 mm Palet 1200x800x1215 mm	Retráctil 600x400x875 mm Palet 1200x800x1210 mm	Retráctil 605x405x120 mm



Euro-Cajas con Tapa para Almacén y Transporte

Euro Box with Cover

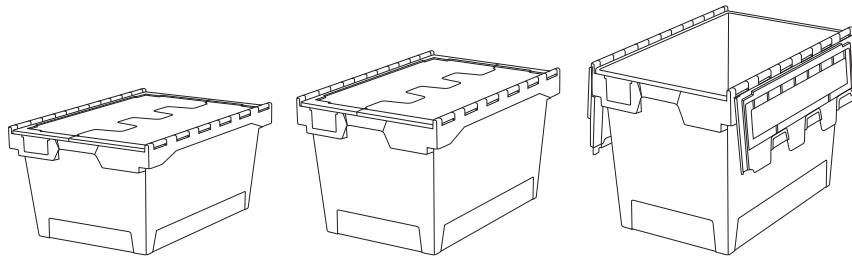

Modelo Model	6424-T	6434-T	6444-T
Código Code	265006	266003	267000
Medidas Sizes	600x400x240 mm	600x400x340 mm	600x400x440 mm
Capacidad (Litros) Capacity (Liters)	39 l.	58 l.	75 l.
Peso (Kg.) Weight (Kg.)	2,49 Kg.	2,98 Kg.	3,69 Kg.
Material	PP	PP	PP
Color Colour	Azul Blue	Azul Blue	Azul Blue
Embalaje Packing	Retráctil 6 Palet 56	Retráctil 6 Palet 48	Retráctil 6 Palet 32
Medidas Embalaje Packing Sizes	Retráctil 600x480x585 mm Palet 1200x960x1285 mm	Retráctil 600x480x690 mm Palet 1200x960x1250 mm	Retráctil 600x480x870 mm Palet 1200x960x1200 mm

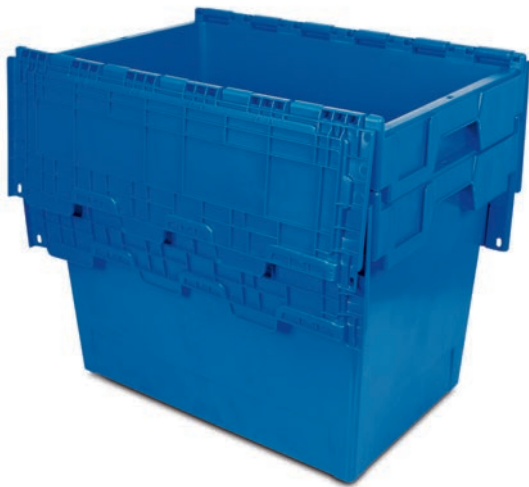

Cajones Estanterías

Drawers for Shelves

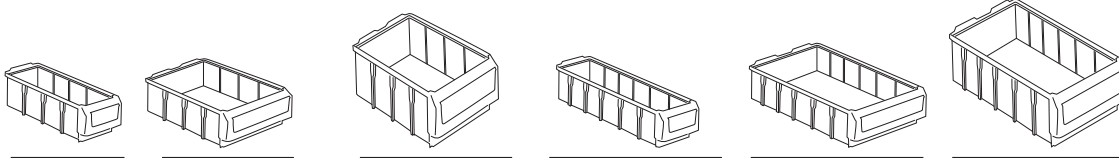

Modelo Model	301	302	303	401	402	403
Código Code	355004	356001	357008	360008	361005	362002
Medidas Sizes	291x116x90 mm	291x232x90 mm	291x232x140 mm	391x116x90 mm	391x232x90 mm	331x232x140 mm
Material	Cajones PP Drawers	Cajones PP Drawers	Cajones PP Drawers	Cajones PP Drawers	Cajones PP Drawers	Cajones PP Drawers
Color Colour	Azul Blue	Azul Blue	Azul Blue	Azul Blue	Azul Blue	Azul Blue
Capacidad (Litros) Capacity (Liters)	2	4,4	7	2,7	6,1	9,7
Embalaje Packing	20 unid.	10 unid.	8 unid.	20 unid.	10 unid.	8 unid.
Medidas Embalaje Packing Sizes	470x298x434 mm	470x298x434 mm	470x298x558 mm	470x398x434 mm	470x398x434 mm	470x398x558 mm



Separadores

Dividers

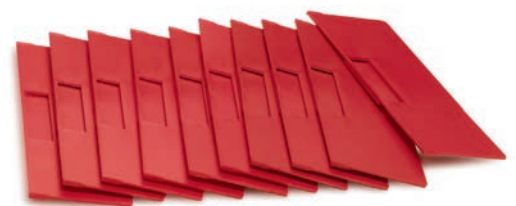
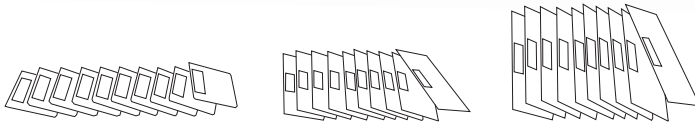

Modelo Model	01	02	03
Código Code	390005	391002	392009
Medidas Sizes	103x79 mm	219x79 mm	219x129 mm
Material	PS	PS	PS
Color Colour	Rojo Red	Rojo Red	Rojo Red
Embalaje Packing	20 unid.	10 unid.	10 unid.

Kit Estantería Metálica

Metal Shelves Kit

Modelo Model	300	400
Código Code	398001	399008
Medidas Sizes	2000x1040x325 mm	2000x1040x425 mm
Contiene Contained	4 Puntales 1 Atirantado 16 Bandejas 300 Acc. 16 Bandejas 300	4 Puntales 1 Atirantado 16 Bandejas 400 Acc. 16 Bandejas 400

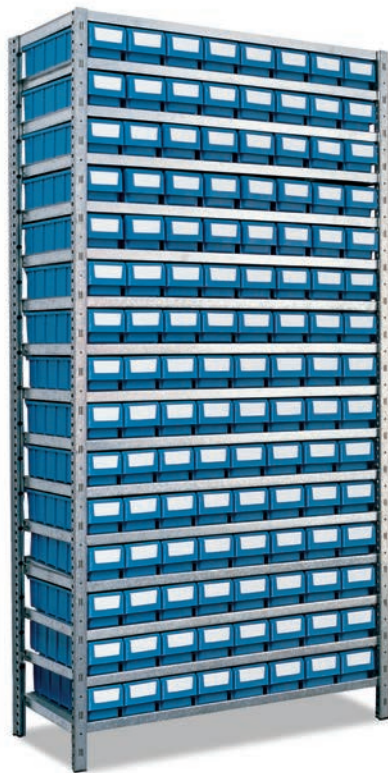

Modelo Model	Kit estantería 301
Código Code	398308
Contiene Contained	1 estantería 300 (16 Bandejas) 120 Cajones 301 18 20-Separadores 01

Modelo Model	Kit estantería 401
Código Code	399305
Contiene Contained	1 estantería 400 (16 Bandejas) 120 Cajones 401 30 20-Separadores 01

Modelo Model	Kit estantería 302
Código Code	398315
Contiene Contained	1 estantería 300 (16 Bandejas) 60 Cajones 302 18 10-Separadores 02

Modelo Model	Kit estantería 402
Código Code	399312
Contiene Contained	1 estantería 400 (16 Bandejas) 60 Cajones 402 30 10-Separadores 02

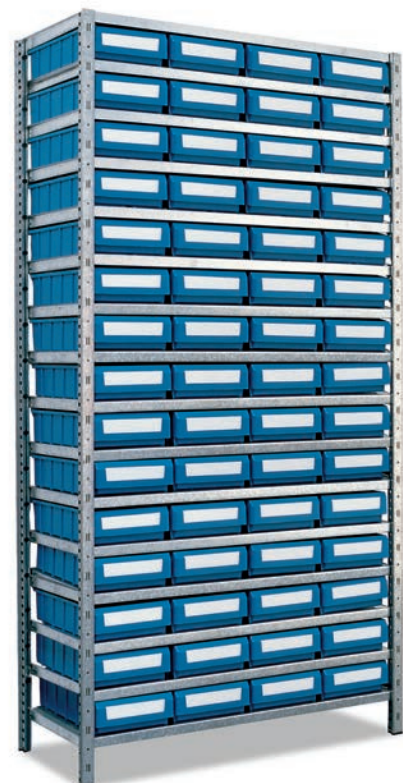

Kit Estantería Metálica con Cajones

Metal Shelves kit with Drawers



Modelo Kit estantería 303
Model

Código 398322
Code

Contiene 1 estantería 300
Contained (12 Bandejas)
48 Cajones 303
13 10-Separadores 03

Modelo Kit estantería 403
Model

Código 399329
Code

Contiene 1 estantería 400
Contained (12 Bandejas)
48 Cajones 403
15 10-Separadores 03

Modelo Kit estantería 310
Model

Código 398339
Code

Contiene 1 estantería 300
Contained (15 Bandejas)
40 Cajones 301
20 Cajones 302
16 Cajones 303
6 20-Separadores 01
6 10-Separadores 02
4 10-Separadores 03

Modelo Kit estantería 410
Model

Código 399336
Code

Contiene 1 estantería 400
Contained (15 Bandejas)
40 Cajones 401
20 Cajones 402
16 Cajones 403
10 20-Separadores 01
10 10-Separadores 02
8 10-Separadores 03



Kit Estantería Plástico

Plastic Shelves Kit

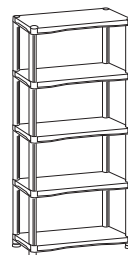
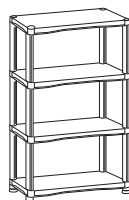
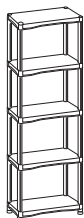
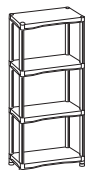

Modelo Model	744	745	944	945
Código Code	226007	225000	221002	220005
Medidas Sizes	1366x700x400 mm	1800x700x400 mm	1366x900x400 mm	1800x900x400 mm
Contiene Contained	4 Bandejas 12 Puntales 16 Casquillos reguladores 4 Tapones 4 Pies 2 Soportes estantería	5 Bandejas 16 Puntales 20 Casquillos reguladores 6 Tapones 6 Pies 3 Soportes estantería	4 Bandejas 12 Puntales 16 Casquillos reguladores 4 Tapones 4 Pies 2 Soportes estantería	5 Bandejas 16 Puntales 20 Casquillos reguladores 6 Tapones 6 Pies 3 Soportes estantería
Material	Resina PP	Resina PP	Resina PP	Resina PP
Embalaje Packing	1 unid.	1 unid.	1 unid.	1 unid.
Medidas Embalaje Packing Size	700x400x200 mm	700x400x250 mm	900x400x200 mm	900x400x250 mm



Kit Estantería Plástico con Cajones

Plastic Shelves Kit with Drawers



Modelo Model	56-A
Código Code	222023
Color Colour	Gaveta Azul Estantería Negro
Medidas Sizes	1800x900x400 mm
Contiene Contained	24 Gavetas-56 (3 cajas de 8 unid.) 8 Bandejas 16 Puntales 32 casquillos regulables 4 Tapones 4 Pies 2 Soportes estantería
Material	Estantería Resina PP Gavetas PP



Modelo Model	56-R
Código Code	222108
Color Colour	Gaveta Rojo Estantería Negro
Medidas Sizes	1800x900x400 mm
Contiene Contained	24 Gavetas-56 (3 cajas de 8 unid.) 8 Bandejas 16 Puntales 32 casquillos regulables 4 Tapones 4 Pies 2 Soportes estantería
Material	Estantería Resina PP Gavetas PP

Módulos Metálicos

Metal Stackable Modules



Modelo
Model 35/2/1

Código
Code 313004

Medidas
Sizes 305x145x462 mm

Embalaje
Packing 4 unid.

Material
Material Armazón - Chapa de acero - Pintura epoxi
Frame - Steel sheet
Cajones PP
Drawers

Medidas
Embalaje
Packing Sizes 650x495x345 mm



Modelo
Model 50/0/0

Código
Code 314001

Medidas
Sizes 305x145x462 mm

Embalaje
Packing 4 unid.

Material
Material Armazón - Chapa de acero - Pintura epoxi
Frame - Steel sheet
Cajones PP
Drawers

Medidas
Embalaje
Packing Sizes 650x495x345 mm



Modelo
Model 20/2/1

Código
Code 315008

Medidas
Sizes 305x145x328 mm

Embalaje
Packing 4 unid.

Material
Material Armazón - Chapa de acero - Pintura epoxi
Frame - Steel sheet
Cajones PP
Drawers

Medidas
Embalaje
Packing Sizes 665x335x355 mm



Modelo
Model 35/0/0

Código
Code 316005

Medidas
Sizes 305x145x328 mm

Embalaje
Packing 4 unid.

Material
Material Armazón - Chapa de acero - Pintura epoxi
Frame - Steel sheet
Cajones PP
Drawers

Medidas
Embalaje
Packing Sizes 665x335x355 mm



Modelo
Model 10/2/1

Código
Code 317002

Medidas
Sizes 305x145x237 mm

Embalaje
Packing 4 unid.

Material
Material Armazón - Chapa de acero - Pintura epoxi
Frame - Steel sheet
Cajones PP
Drawers

Medidas
Embalaje
Packing Sizes 650x335x260 mm



Modelo
Model 25/0/0

Código
Code 318009

Medidas
Sizes 305x145x237 mm

Embalaje
Packing 4 unid.

Material
Material Armazón - Chapa de acero - Pintura epoxi
Frame - Steel sheet
Cajones PP
Drawers

Medidas
Embalaje
Packing Sizes 650x335x260mm

Contenedores Basculantes

Cabinet with Tiltable Drawers

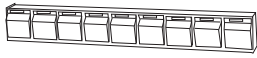

Gris
Grey

Código
Code **339066**

Cajones
Drawers 9

Medidas
Sizes 600x63x81

Material PS

Embalaje
Packing 12 unid.

Medidas
Embalaje
Packing
Size 605x270x250

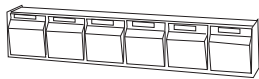

Gris
Grey

Código
Code **336065**

Cajones
Drawers 6

Medidas
Sizes 600x92x114

Material PS

Embalaje
Packing 12 unid.

Medidas
Embalaje
Packing
Size 605x405x355

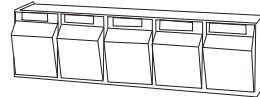

Gris
Grey

Código
Code **335068**

Cajones
Drawers 5

Medidas
Sizes 600x133x165

Material PS

Embalaje
Packing 6 unid.

Medidas
Embalaje
Packing
Size 605x440x350

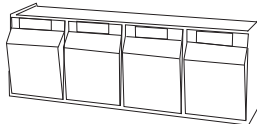

Gris
Grey

Código
Code **334061**

Cajones
Drawers 4

Medidas
Sizes 600x168x206

Material PS

Embalaje
Packing 6 unid.

Medidas
Embalaje
Packing
Size 605x350x635

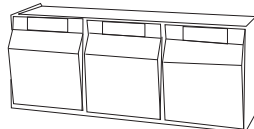

Gris
Grey

Código
Code **333064**

Cajones
Drawers 3

Medidas
Sizes 600x196x241

Material PS

Embalaje
Packing 4 unid.

Medidas
Embalaje
Packing
Size 605x410x490

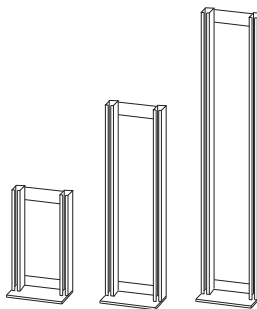

Soporte
Código
Code **340000** **341007** **342004**

Medidas
Sizes 60 cm. 121 cm. 177 cm.

Varilla
Cierre



Código
Code **343001**

Código
Code **344008** (10 Tornillos y arandelas)

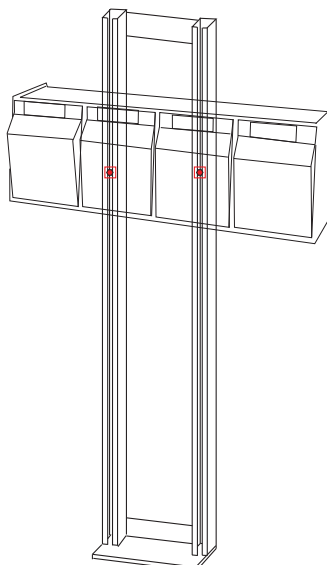

Contenedores Cajones

Cabinets with Drawers

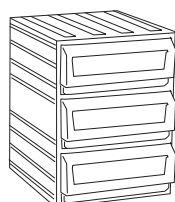
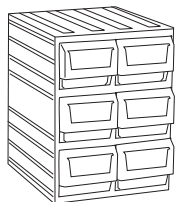

Modelo Model	300/6	300/3	300/5
Código Code	350009	351006	352003
Medidas Exteriores Outer Sizes	245x291x321 mm	245x291x321 mm	245x291x321 mm
Cajones Drawers	6 291x116x95 mm	3 291x232x95 mm	4 291x116x95 mm
Medidas Sizes			1 291x232x95 mm
Separador Cajones Drawers Separator	18	9	12 3
Material	Armazón PS Frame Cajones PP Drawers	Armazón PS Frame Cajones PP Drawers	Armazón PS Frame Cajones PP Drawers
Color Colour	Armazón Negro Frame Black Cajones Azul Drawers Blue	Armazón Negro Frame Black Cajones Azul Drawers Blue	Armazón Negro Frame Black Cajones Azul Drawers Blue
Embalaje Packing	2 unid.	2 unid.	2 unid.
Medidas Embalaje Packing Sizes	496x298x330 mm	496x298x330 mm	496x298x330 mm



Ensamble sobre guías
Assembling on guides

Estantes Clasificadores Apilables

Stackable Classifiers Shelf Unit

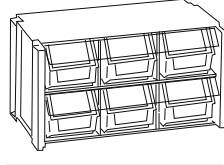
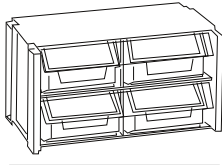

Código
Code

304002

306006

Medidas Exteriores
Outer Sizes

360x170x190 mm

360x170x190 mm

Gavetas
Drawers

4

6

Medidas
Sizes

160x170x80 mm

100x170x80 mm

Material

Armazón PS
Frame
Gavetas PP
Drawers

Armazón PS
Frame
Gavetas PP
Drawers

Color
Colour

Armazón Negro
Frame Black
Gavetas Rojas
Drawers Red

Armazón Negro
Frame Black
Gavetas Rojas
Drawers Red

Embalaje
Packing

4 unid.

4 unid.

Medidas Embalaje
Packing Sizes

365x356x380 mm

365x356x380 mm

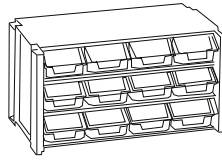
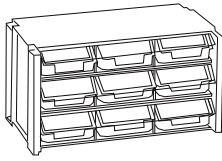

Código
Code

309007

312007

Medidas Exteriores
Outer Sizes

360x170x190 mm

360x170x190 mm

Gavetas
Drawers

9

12

Medidas
Sizes

100x170x50 mm

80x170x50 mm

Material

Armazón PS
Frame
Gavetas PP
Drawers

Armazón PS
Frame
Gavetas PP
Drawers

Color
Colour

Armazón Negro
Frame Black
Gavetas Rojas
Drawers Red

Armazón Negro
Frame Black
Gavetas Rojas
Drawers Red

Embalaje
Packing

4 unid.

4 unid.

Medidas Embalaje
Packing Sizes

365x356x380 mm

365x356x380 mm



Módulos Apilables

Stackable Modules

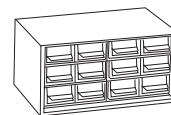
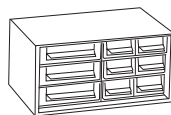
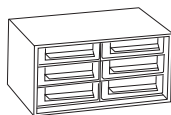
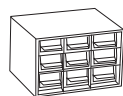

Código Code	345005	346002	347009	348006
Medidas Exteriores Outer Sizes	218x167x140 mm	280x167x140 mm	280x167x140 mm	280x167x140 mm
Cajones Drawers Medidas Sizes	9 150x62x37 mm	6 150x127x37 mm	3 150x127x37 mm 6 150x62x37 mm	12 150x62x37 mm
Separador Cajones Drawers Separator	9 unid.	6 unid.	3 unid. 6 unid.	12 unid.
Material	PS	PS	PS	PS
Color Colour	Armazón Verde Frame Green Gavetas Transparente Drawers Transparent	Armazón Verde Frame Green Gavetas Transparente Drawers Transparent	Armazón Verde Frame Green Gavetas Transparente Drawers Transparent	Armazón Verde Frame Green Gavetas Transparente Drawers Transparent
Embalaje Packing	6 unid.	6 unid.	6 unid.	6 unid.
Medidas Embalaje Packing Sizes	345x224x440 mm	345x290x440 mm	345x290x440 mm	345x290x440 mm



Módulos Bandejas

Tray Modules

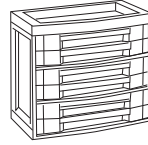
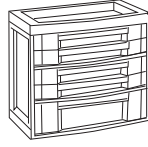

Modelo Model	1	2	3
Código Code	321009	322006	323003
Medidas Exteriores Outer Sizes	290x167x255 mm	290x167x255 mm	290x167x255 mm
Bandeja Tray	3 256x162x65 mm	1 256x162x65 mm	6 256x162x30 mm
Medidas Sizes		4 256x162x30 mm	
Material	Armazón PS Frame	Armazón PS Frame	Armazón PS Frame
	Bandeja PP Tray	Bandeja PP Tray	Bandeja PP Tray
Color Colour	Armazón Rojo Frame Red	Armazón Rojo Frame Red	Armazón Rojo Frame Red
	Bandeja Transparente Tray Transparent	Bandeja Transparente Tray Transparent	Bandeja Transparente Tray Transparent
Embalaje Packing	4 unid.	4 unid.	4 unid.
Medidas Embalaje Packing Sizes	345x304x490 mm	345x304x490 mm	345x304x490 mm



Bidones con Cánula (vertedero)

Jerry cans with Spout (for pouring)

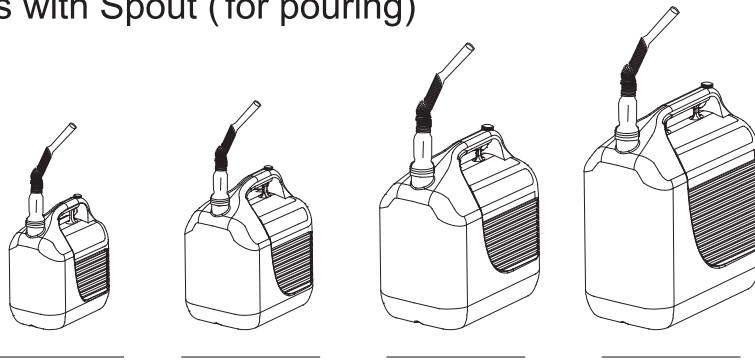

Código Code	601354	602351	603358	604355
Capacidad Capacity	5 l.	10 l.	20 l.	30 l.
Medidas Sizes	230x145x257 mm	265x200x307 mm	345x234x377 mm	400x237x464 mm
Material	HDPE	HDPE	HDPE	HDPE
Embalaje Packing	6 unid.	6 unid.	5 unid.	5 unid.
Medidas Embalaje Packing Sizes	780x290x230 mm	780x396x307 mm	1175x377x345 mm	1180x400x464 mm



Homologados para transporte de mercancías peligrosas clases 3, 6.1, 8 y 9
Norma ADR (Transporte Internacional Carretera)
Norma RID (Transporte Internacional por Ferrocarril)
Norma IMDG (Transporte Internacional Marítimo)
Norma IATA/OACI (Transporte Internacional Aéreo)

Presión Hidráulica 200 kPa

Clase Class	Grupo Group	Descripción Description	Ejemplos Examples
3	Y	Inflamables	Gasolina, gasoil, otros hidrocarburos, acetona, alcoholes (metanol, etanol...) aldehidos, benceno, tolueno, xileno, éteres, ésteres, aceites, disolventes, lacas, pinturas, esmaltes, barniz...
6.1	Y	Tóxicos	Anilinas, cloroformo, desinfectantes, plaguicidas, bencidina y compuestos de: mercurio, plomo, bario, berilio, arsénio, antimonio, talio, cianuro...
8	Y	Corrosivos	Ácidos (sulfúrico, nítrico, fosfórico, acético, fórmico...), sulfumán Hidróxidos de: potasio, sosa, litio... Lejías, amoníaco, electrolitos, soluciones cáusticas...
9	Y	Varios	Amiantos, difenilos policlorados, material líquido peligroso para el medio ambiente...



Tapones y Cánulas

Caps and Spouts

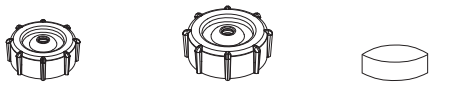

Código Code	607004	608001	616006
Capacidad Capacity	5 l. y 10 l.	20 l. y 30 l.	

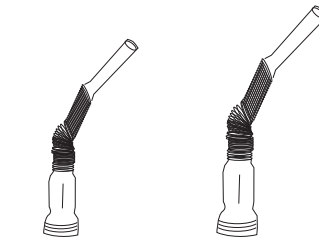

Código Code	605000	606007
Capacidad Capacity	5 l. y 10 l.	20 l. y 30 l.



Bidones con Tapón/Grifo

Jerry cans with Cap/Tap

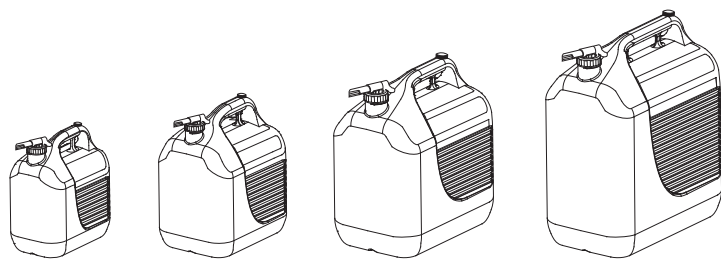

Código Code	601361	602368	603365	604362
Capacidad Capacity	5 l.	10 l.	20 l.	30 l.
Medidas Sizes	230x145x257 mm	265x200x307 mm	345x234x377 mm	400x237x464 mm
Material	HDPE	HDPE	HDPE	HDPE
Embalaje Packing	6 unid.	6 unid.	5 unid.	5 unid.
Medidas Embalaje Packing Sizes	780x290x230 mm	780x396x307 mm	1175x377x345 mm	1180x400x464 mm



APTO PARA USO ALIMENTARIO
Registro sanitario / Health registration
n° 3900923/V

NO USAR HIDROCARBUROS
DO NOT USE HYDROCARBON

Tapón grifo

Cap/Tap

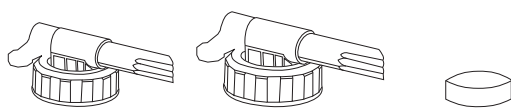

Código Code	609008	610004	617003
Capacidad Capacity	5 l. y 10 l.	20 l. y 30 l.	



Bidón Metálico con Cánula (vertedero)

Metal Jerry cans with Spout (for pouring)

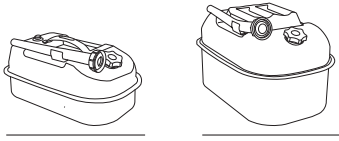

Código Code	602382	603389
Capacidad Capacity	10 l.	20 l.
Medidas Sizes	390x245x195 mm	430x305x285 mm
Material	Acero Galvanizado y pintado de 0,6 mm Galvanized and painted steel of 0,6 mm	Acero Galvanizado y pintado de 0,6 mm Galvanized and painted steel of 0,6 mm
Embalaje Packing	1 unid.	1 unid.
Medidas Embalaje Packing Sizes	410x250x200 mm	440x310x290 mm



Homologados para transporte de mercancías peligrosas, clase 3
Norma ADR (Transporte Internacional Carretera)
Norma RID (Transporte Internacional por Ferrocarril)
Norma IMDG (Transporte Internacional Marítimo)

Presión Hidráulica 250 kPa

VÁLIDO PARA HIDROCARBUROS
 (gasolina, gasoil y derivados)
 VALID FOR HYDROCARBON



Tapones y Cánulas

Caps and Spouts



Código
Code

614002

615009

Código
Code

612008

Bidón Metálico con Cánula (vertedero)

Metal Jerry cans with Spout (for pouring)

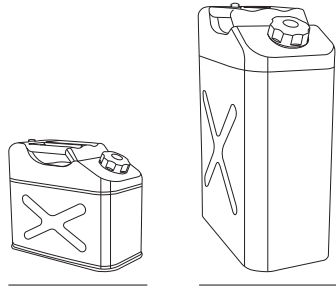

Código Code	602375	603372
Capacidad Capacity	10 l.	20 l.
Medidas Sizes	350x175x290 mm	350x175x475 mm
Material	Acero Galvanizado y pintado de 0,8 mm Galvanized and painted steel of 0,8 mm	Acero Galvanizado y pintado de 0,8 mm Galvanized and painted steel of 0,8 mm
Embalaje Packing	1 unid.	1 unid.
Medidas Embalaje Packing Sizes	350x180x290 mm	350x180x475 mm



Homologados para transporte de mercancías peligrosas, clase 3
Norma ADR (Transporte Internacional Carretera)
Norma RID (Transporte Internacional por Ferrocarril)
Norma IMDG (Transporte Internacional Marítimo)

Presión Hidraulica 250 kPa

Cánula incluida en el interior del bidón.
 Spout included inside container.

VÁ LIDO PARA HIDROCARBUROS
 (gasolina, gasoil y derivados)
 VALID FOR HYDROCARBON



Tapones y Cánulas

Caps and Spouts



Código
Code

613005



615009



Código
Code

611001



Suministros Industriales del Tajo S.A.

C/ del Río Jarama 52 - 45007, Toledo - Spain

Tel.: 925 23 22 00 - Fax: 925 23 21 47

Email: sitasa@sitasa.com

www.sitasa.com