



**SITASA**

**Suministros Industriales del Tajo, S.A.**

C/ Jarama 52, Polígono Industrial, 45007 Toledo (Spain)

Tel: (34) 925 23 22 00

Fax: (34) 925 23 21 47

[www.sitasa.com](http://www.sitasa.com)









[sitasa@sitasa.com](mailto:sitasa@sitasa.com)



# HERRAMIENTAS DE MANO

## CATÁLOGO 2010



	<b>1000</b>	2		<b>CONJUNTOS</b>	27		<b>1700</b>	47
	<b>9100</b>	4		<b>1300ALT</b>	30		<b>2600</b>	48
	<b>1010HF</b>	6		<b>CONJUNTOS</b>	28		<b>1500</b>	50
	<b>9000</b>	8		<b>CONJUNTOS</b>	29		<b>2500</b>	52
	<b>2400</b>	10		<b>1400T-1400LT</b>	34		<b>4300/4400</b>	54
	<b>1100</b>	12		<b>2650</b>	35		<b>4700</b>	58
	<b>1200</b>	14		<b>1950</b>	35		<b>1600</b>	60
	<b>1100S</b>	15		<b>7300</b>	36		<b>4100</b>	64
	<b>1100H</b>	16		<b>7300T</b>	38		<b>FILTROS</b>	70
	<b>1108H</b>	18		<b>7300T/ALT</b>	39		<b>TORNILLOS ROTOS</b>	73
	<b>1500H</b>	19		<b>1750</b>	40		<b>RÓTULAS</b>	78
	<b>1300</b>	20		<b>1800</b>	42		<b>SUSPENSIÓN</b>	82
	<b>1300T</b>	22		<b>1900</b>	44		<b>AUTOMÓVIL</b>	83
	<b>JUEGOS</b>	23					<b>ABCARDORES</b>	85
	<b>1300H/TH</b>	24					<b>PERFORADORES</b>	88
	<b>1300CT</b>	26						

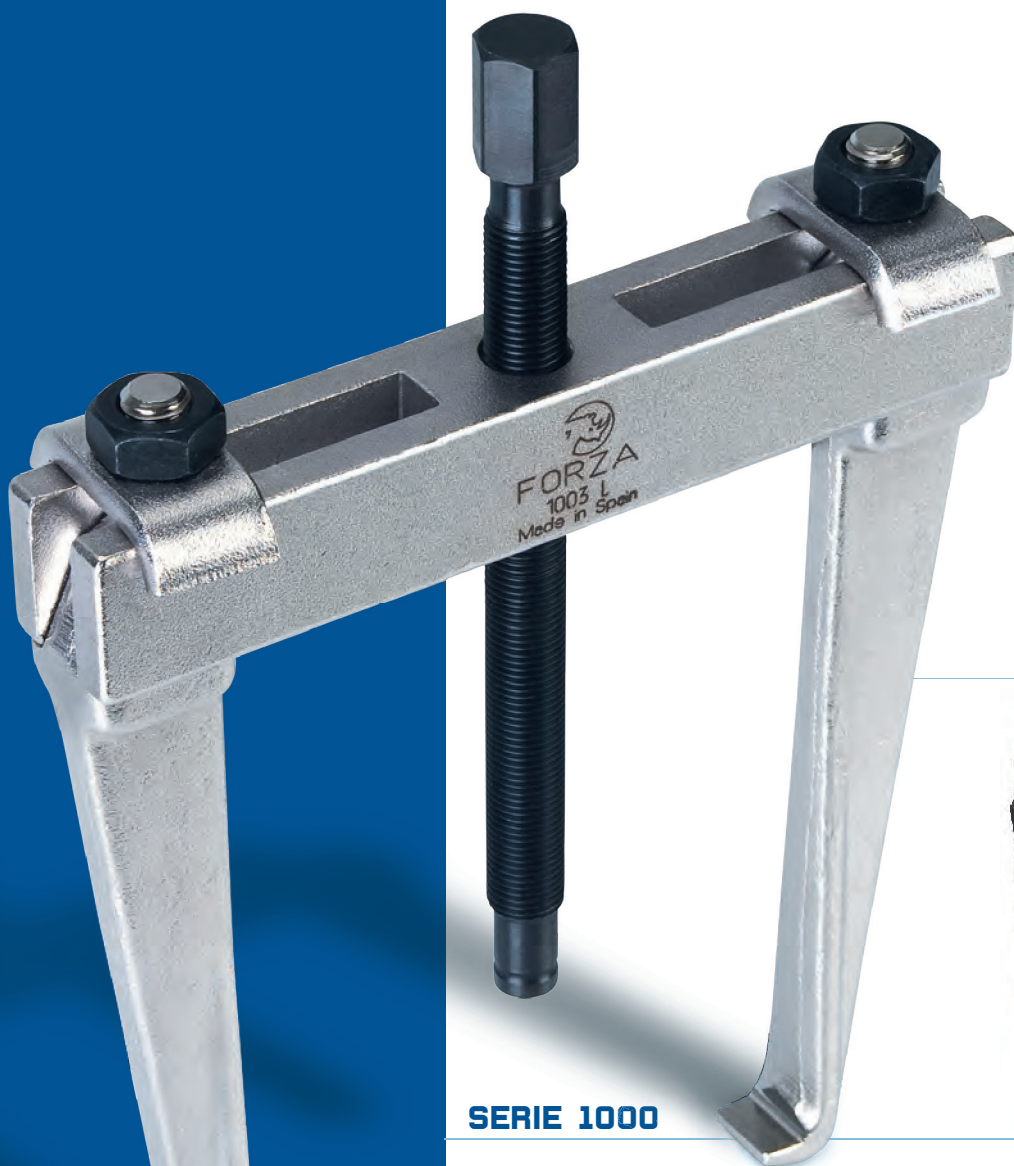

SERIE 1000

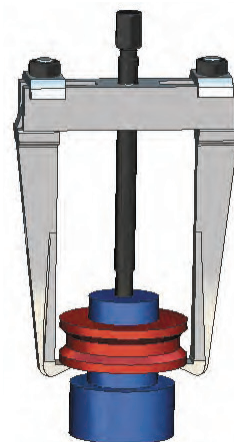

EXPOSITOR · MERCHANDISER · PRÉSENTOIR

Ref.	composición	△△
1000A	1002 - 1003L - 1010 - 1010L - 1015	16,2
1000B	1002 - 1003L - 1010 - 1015 - 1020	22,7



# SERIE 1000



Extractor mecánico 2 patas rígidas, interior y exterior  
 2 jaws manual puller, internal and external  
 Extracteurs avec 2 griffes, interieur et exterior

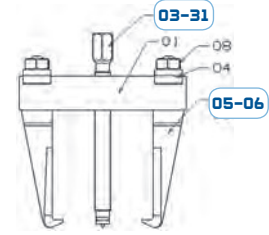

Ref.	A	B max	B min	W max	W min	C	TON.	⚖️
1001	50	60	12	80	55	72	1	0,3
1002	80	80	25	130	105	122	2	1
1002L	135	80	20	132	108	122	2	1,2
1003	80	115	25	160	105	156	2	1,1
1003L	135	115	25	165	108	156	2	1,3
1010	160	155	30	222	159	210	10	2,4
1010L	220	145	40	215	162	210	10	4
1010A	160	195	40	277	166	260	10	3,6
1015	220	195	50	270	173	260	10	4,4
1020	260	250	75	335	222	345	20	10,5
1020A	260	390	125	465	278	475	20	13
1020L	390	245	80	340	243	345	20	13,5
1020LA	390	375	125	485	292	475	20	15,8

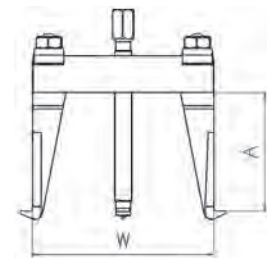
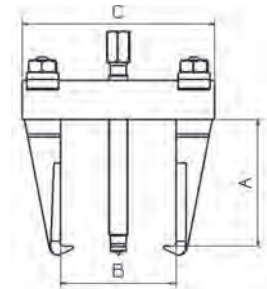

A: Cuerpo ancho · Large body · Corps large  
 L: Pata larga · Long jaw · Griffes longue

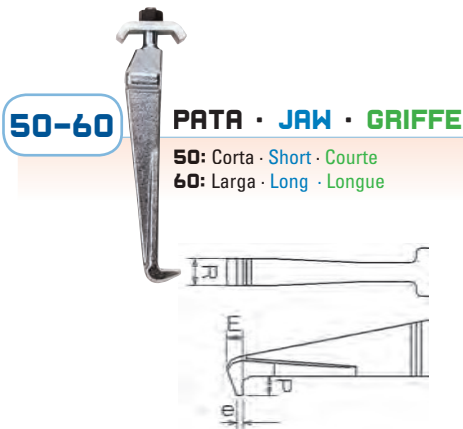

Ref.	P	R	E	e	⚙️
100150	5	9	4	2	1001
100250	8	12	6	2,5	1002 - 1003
100260	8	12,5	6	2,5	1002L - 1003L
101050	17	26	10	4,5	1010 - 1010A
101060	16,5	27,5	11	4,5	1010L - 1015
102050	18,5	35,5	13	5	1020 - 1020A
102060	24	36	18,5	5,5	1020L - 1020LA

Pata completa 50= Pata (05) + Brida (04) + Tuerca (08)  
 Pata larga completa 60= Pata L (06) + Brida (04) + Tuerca (08)



Ref.	M	L	X	H	⚙️	⚙️
100103	8 x 1	85	10	12	● fijo	1001
100203	12 x 1,25	140	20	14	● fijo	1002 - 1003
110203	12 x 1,25	165	20	14	● fijo	1002L - 1003L
101031	20 x 1,50	255	25	22	■ /www	1010 - 1010A
131031	20 x 1,50	320	25	22	■ /www	1010L - 1015
131731	27 x 2	377	30	27	■ /www	1020 - 1020A - 1020L - 1020LA

Husillo 31 = Husillo (03) + Punto (09)



**SERIE 9100**

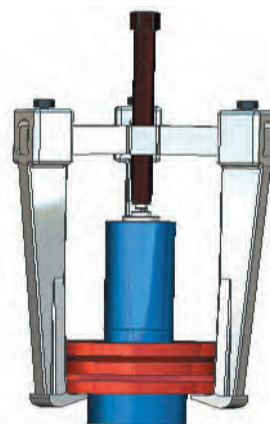

**SERIE 9100T**

Extractor mecánico de tres patas rígidas para interiores y exteriores  
**3 jaws manual puller, internal and external**  
 Extracteurs avec 3 griffes, intérieur et extérieur



# SERIE 9100



Extractor mecánico 2 patas rígidas, interior y exterior  
 2 jaws manual puller, internal and external  
 Extracteurs avec 2 griffes, interieur et exterior

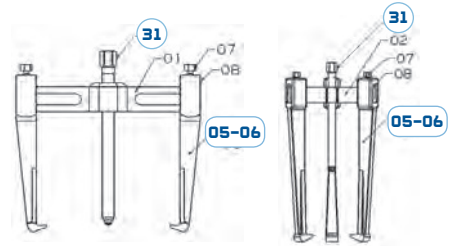

Ref. 2 PATAS	A	B máx	B mín.	W máx	W mín.	C	TON.	
9120	200	200	30	295	163	280	15	5,5
9120L	380	185	50	280	188	280	15	9
9122	200	250	50	345	183	330	15	6
9122L	380	225	60	345	220	330	15	9,5
9124	200	340	65	435	194	420	15	6,5
9124L	380	318	60	420	215	420	15	10
9130	375	340	75	445	222	440	20	13,5
9132	375	455	80	565	235	550	20	14,7
9134	375	555	105	660	268	650	20	15,7

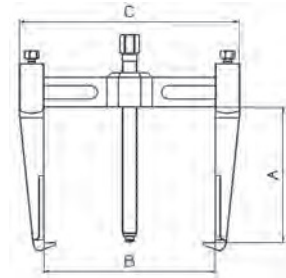

Ref. 3 PATAS	A	B máx	B mín.	W máx	W mín.	C	TON.	
9120T	200	200	30	295	163	280	15	7,7
9120LT	380	185	50	280	188	280	15	13,8

T: 3 patas · 3 jaws · 3 griffes  
 L: Pata larga · long jaw · griffe longue

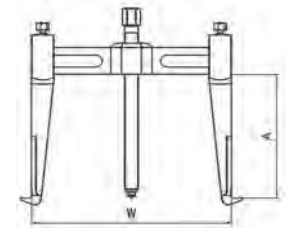

**50-60** **PATA · JAW · GRIFFE**  
 50: Corta · Short · Courte  
 60: Larga · Long · Longue



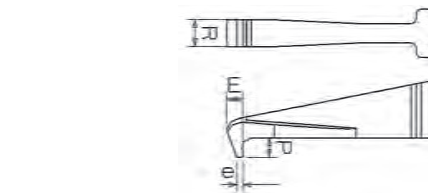

**31** **HUSILLO · SPINDLE · VIS**  
 09: Punto · Point · Point

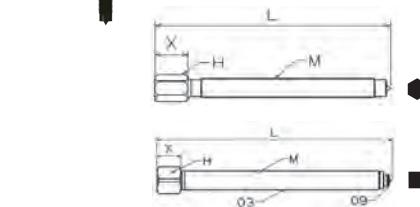

Ref.	P	R	E	e	
912050	16,5	30,5	12	3,5	9120/9122/9124/9120T
912060	24	35,5	20	6	9120L/9122L/9124L/9120LT
913050	24	35,5	21	6	9130/9132/9134

Pata completa 50 = Pata (05) + Tornillo (07) + Tuerca (08)  
 Pata completa 60 = Pata L (06) + Tornillo (07) + Tuerca (08)



Ref.	M	L	X	H		
912031	22 x 2	317	30	26		9120/9120L/9120T/9120LT 9122/9122L/9124/9124L
131731	27 x 2	377	30	27		9130/9132/9134

Husillo 31 = Husillo (03) + Punto (09)

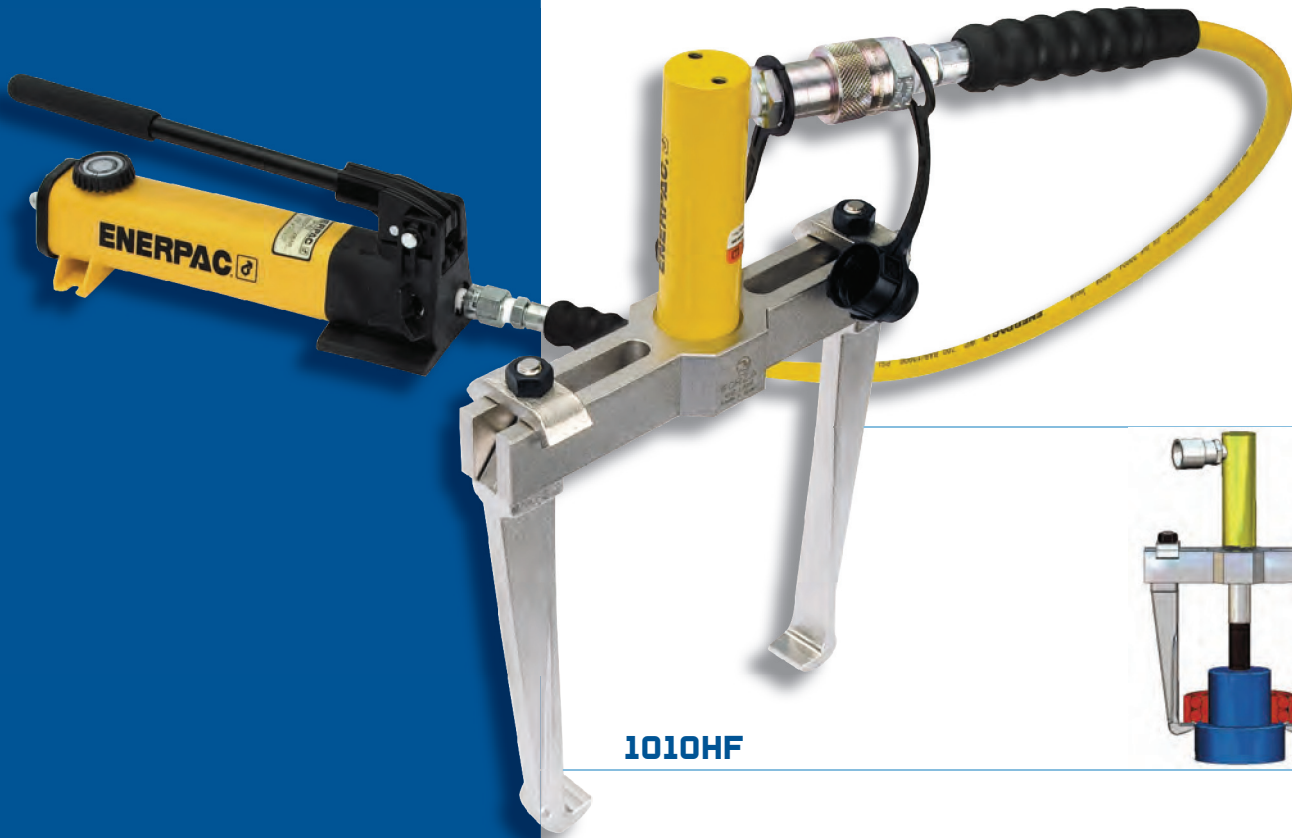

**1010HF**

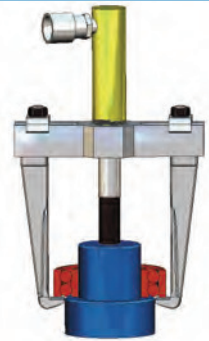

**1018H**



**1010H**

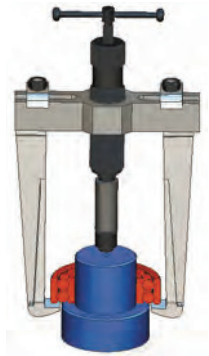

**00918**



**00904**



# SERIE 1010H



Extractor hidráulico 2 patas rígidas, interior y exterior

2 jaws hydraulic puller, internal and external

Extracteurs hydraulique avec 2 griffes, interieur et exterior

Ref.	A	B máx	B mín.	W máx	W mín.	C	TON.	
1010H	160	150	60	215	172	210	8	4,8
1010LH	220	150	60	215	172	210	8	5,5
1010AH	160	200	60	270	175	260	8	5,1
1010LAH	220	200	60	270	175	260	8	5,8

## HUSILLO · SPINDLE · VIS

150000 8Tn

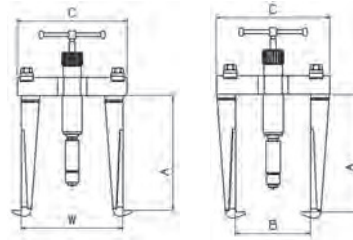
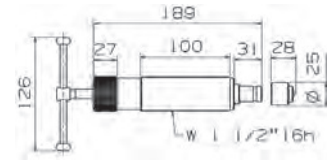



# SERIE 1010HF

Parte hidráulica 00904

Hydraulic set 00904

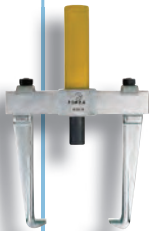
Partie hydraulique 00904



Ref.	A	B máx	B mín.	W máx	W mín.	C	TON.	
1010HF	160	150	60	215	172	210	4	8,0
1010LHF	220	150	60	215	172	210	4	8,5
1010AHF	160	200	60	270	175	260	4	8,5
1010LAHF	220	200	60	270	175	260	4	9,0

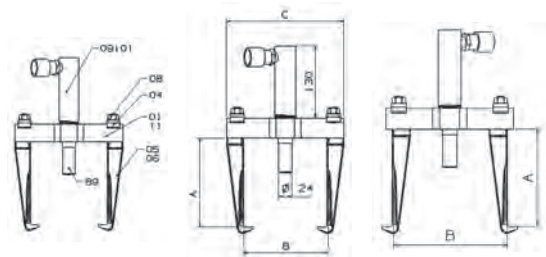

# SERIE 1000H

Parte hidráulica 00918

Hydraulic set 00918

Partie hydraulique 00918



Ref.	A	B máx	B mín.	W máx	W mín.	C	TON.	
1018H	260	280	105	365	257	370	18	21,0
1018HL	390	280	115	370	280	370	18	24,0

## HUSILLO · SPINDLE · VIS

111883 20Tn

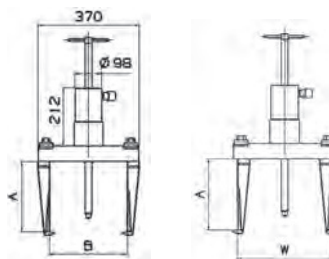
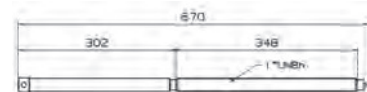

**50-60**



## PATA · JAW · GRIFFE

50: Corta · Short · Courte

60: Larga · Long · Longue

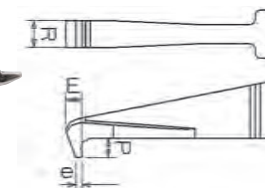

Ref.	P	R	E	e	
101050	17	26	10	4,5	1010H-1010AH-1010HF-1010AHF
101060	16,5	27,5	11	4,5	1010LH-1010LAH-1010LHF-1010LAHF
102050	18,5	35,5	13	5	1018H
102060	24	36	18,5	5,5	1018HL

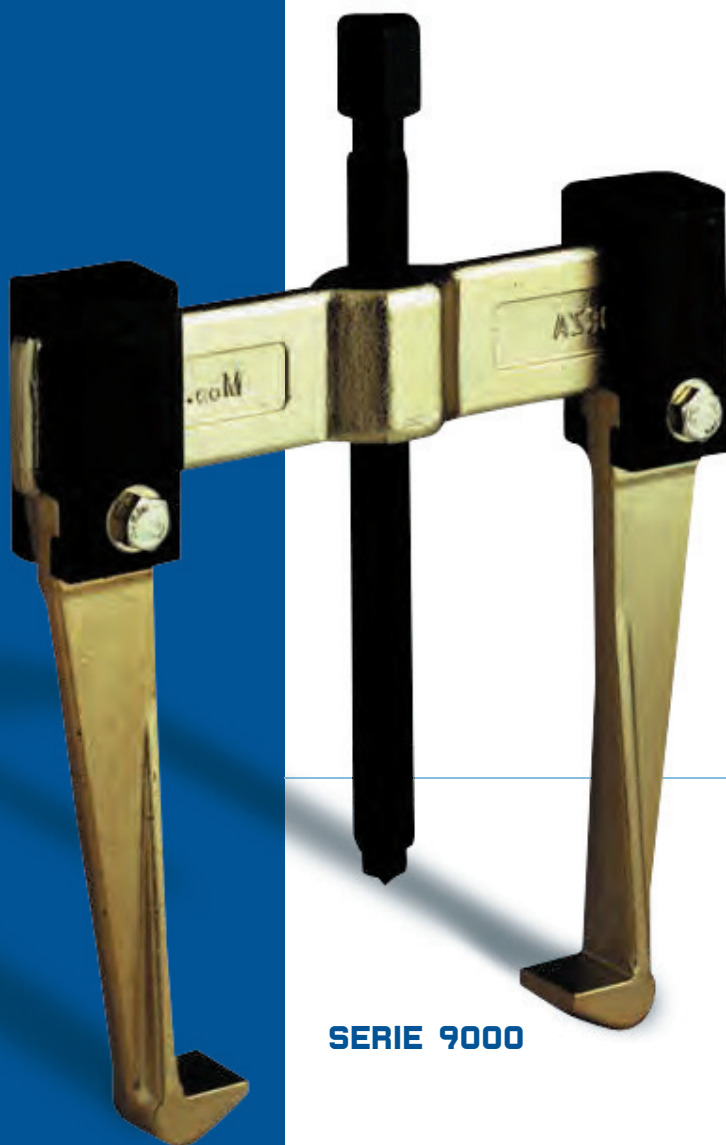

**SERIE 9000**

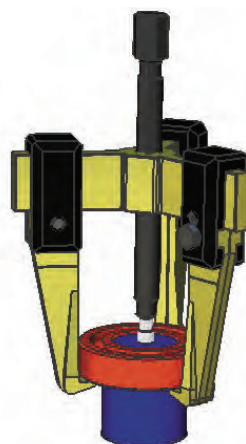

**SERIE 9000T**

Extractor mecánico 3 patas rígidas, interior y exterior  
 3 jaws manual puller, internal and external  
 Extracteur avec 3 griffes, interieur et exterior



**EXPOSITOR · MERCHANDISER · PRÉSENTOIR**

Ref.	composición	⚖
9000A	9002-9002L-9002LA-9010-9010LA	13,0
9000B	9002-9002LA-9010-9010L-9010LA	15,7



# SERIE 9000

Extractor mecánico 2 patas rígidas, interior y exterior  
 2 jaws manual puller, internal and external  
 Extracteur avec 2 griffes, interieur et exterior

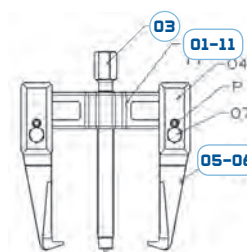

Ref. 2 PATAS	A	B max	B min	W max	W min	C	TON.	
9002	80	80	22	130	92	121	2	0,9
9002L	130	80	22	130	92	121	2	0,9
9002A	80	120	22	170	92	161	2	1
9002LA	130	120	22	170	92	161	2	1
9010	160	160	35	230	147	221	10	3,3
9010L	215	160	35	230	149	221	10	3,6
9010A	160	220	35	275	144	271	10	3,5
9010LA	215	210	35	280	152	271	10	3,8

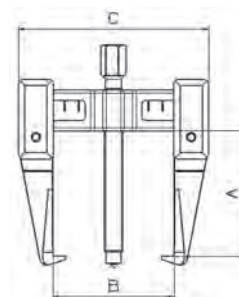

Ref. 3 PATAS	A	B max	B min	W max	W min	C	TON.	
9002T	80	80	22	130	92	120	2	1,2
9002LT	130	80	22	130	92	120	2	1,3
9002AT	80	120	22	170	92	160	2	1,3
9002LAT	130	120	22	170	92	160	2	1,4
9010T	160	160	35	230	150	220	10	4,6
9010LT	215	160	35	230	150	220	10	5,3
9010AT	160	220	35	275	155	270	10	5,1
9010LAT	215	210	35	275	155	270	10	5,7

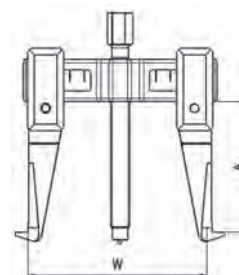

A: Cuerpo ancho · Large body · Corps large  
 T: 3 patas · 3 jaws · 3 griffes  
 L: Pata larga · Long jaw · Griffes longue



**50-60**

**PATA · JAW · GRIFFE**

05: Corta · Short · Courte  
 06: Larga · Long · Longue

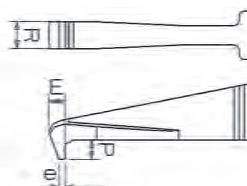

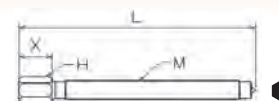

**03**

**HUSILLO · SPINDLE · VIS**



Ref.	P	R	E	e	
900250	8	14	5	2,5	9002 / 9002A 9002T / 9002AT
900260	8	16	5	2,5	9002L / 9002LA 9002LAT / 9002LT
901050	17,5	27,5	14,5	3,5	9010 / 9010A 9010T / 9010AT
901060	18	29	12	6	9010L / 9010LA 9010LAT / 9010LT

Pata completa 50 = Pata (05) + Brida (04) + Tornillo (07)  
 Pata Larga completa 60 = Pata L (06) + Brida (04) + Tornillo (07)

Ref.	M	L	X	H		
900203	12 x 1,75	145	20	14	● fijo	9002 / 9002A / 9002T / 9002AT / 9002L / 9002LA / 9002LAT / 9002LT
901003	18 x 2,5	230	25	22	● fijo	9010 / 9010A / 9010T / 9010AT / 9010L / 9010LA / 9010LAT / 9010LT



**SERIE 2400**

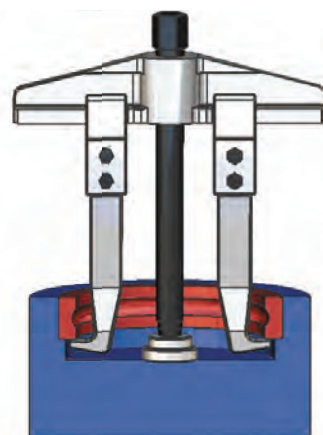

**EXPOSITOR · MERCHANDISER · PRÉSENTOIR**

Ref.	composición
2400A	2410 - 2415 - 2420 - 2425 - 2430

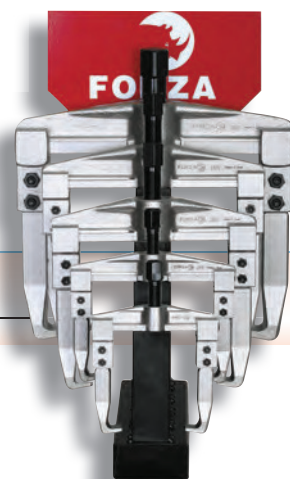

# SERIE 2400



Extractor mecánico 2 patas UNIVERSAL, interior y exterior

2 jaws UNIVERSAL manual puller internal and external

Extracteur UNIVERSAL avec 2 griffes, interieur et exterior

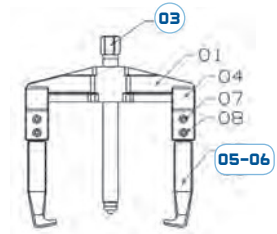

Ref.	A	B max	B min	W max	W min	C	TON.	⚖️
2410	100	95	30	130	92	134	3	1,1
2410L	200	95	25	130	80	134	3	1,3
2415	100	135	35	175	100	176	3	1,3
2415L	200	135	35	175	95	176	3	1,4
2420	150	160	40	225	130	223	7	3,3
2420L	305	165	45	225	130	223	7	3,9
2425	155	190	35	250	135	250	12	3,4
2425L	305	190	35	270	130	250	12	4,1
2430	205	240	50	325	175	325	12	7,5
2430L	380	250	60	340	175	325	12	8,5
2435	200	350	60	425	175	425	12	8,5
2435L	380	350	60	425	180	425	12	15
2440	200	510	90	580	220	585	12	14
2440L	380	510	90	580	220	585	12	25
2450	230	640	140	740	310	717	15	24

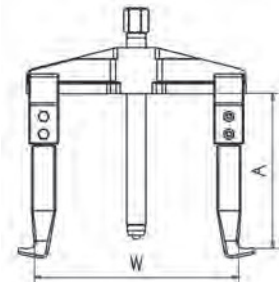
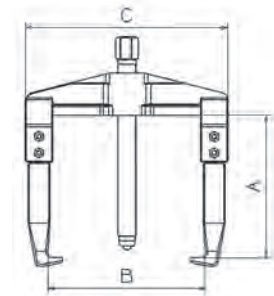

L: Pata larga · Long jaw · Griffe longue



## PATA · JAW · GRIFFE

05: Corta · Short · Courte  
06: Larga · Long · Longue

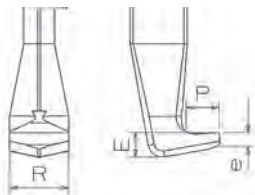

Ref.	P	R	E	e	⚖️
A-90	12,5	20,5	6	3,5	2410 / 2415
A-200	12,5	20	6	3,5	2410L / 2415L
B-150	15	25	7	4	2420 / 2425
B-300	16	25	7	4	2420L / 2425L
C-200	24,5	35	11,5	5,5	2430/2435/2440
C-375	25	34,5	12,5	6	2430L/2435L/2440L
D-225	38	49,5	13,5	9,5	2450

Pata completa = Pata (05) + Brida (04) + Tornillos (07) + Tuerca (08)  
Pata Larga completa = Pata L (06) + Brida (04) + Tornillos (07) + Tuerca (08)



## HUSILLO · SPINDLE · VIS

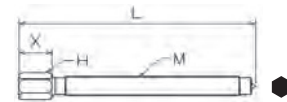
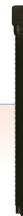

Ref.	M	L	X	H	⚖️	⚖️
241003	14 x 1,50	158	20,5	17	● bola	2410 / 2410L / 2415 / 2415L
242003	20 x 1,50	235	26	22	● bola	2420 / 2420L / 2425 / 2425L
243003	28 x 2	310	30	32	● bola	2430 / 2430L / 2435 / 2435L
244003	1" Gas 11h	338	35	35	● bola	2440 / 2440L / 2450



**SERIE 1100**

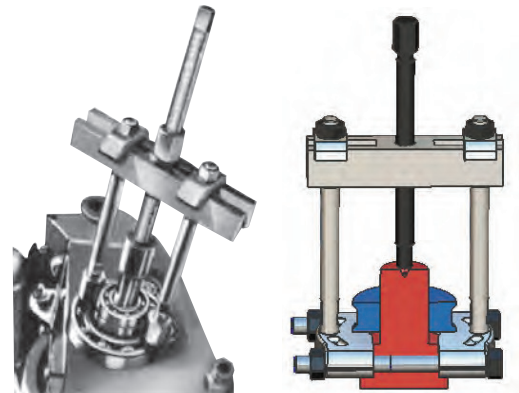

**SERIE 1200**

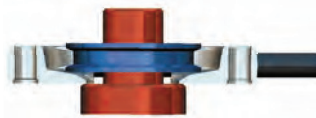

Primero separar  
First the splitting  
D'abord le décollement

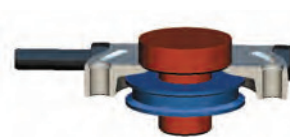

Invertir para extraer  
Reverse for pulling  
Inverser pour l'extraction



Si  
Yes  
Oui

# SERIE 1100



Extractor mecánico 2 alargaderas extensibles  
 2 legs push puller with possible extension  
 Extracteur potence 2 bras avec rallonge possible

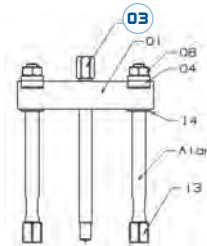

1102-1103

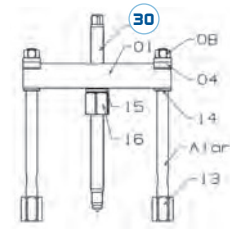

Resto de modelos

Ref.	A	B max	B min	C	TON.	
1102	120	110	46	122	2	1
1103	120	140	46	156	2	1,1
1110	190	195	62	210	10	3,4
1120	255	325	105	346	20	9,5
1128	255	445	173	475	20	12
1135	480	450	178	480	30	35
1150	680	580	219	617	50	53

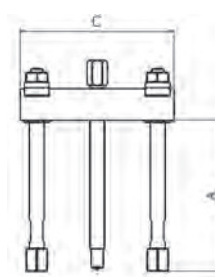

1102-1103

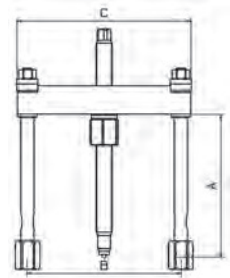

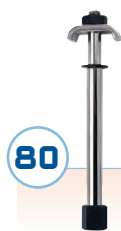

Resto de modelos

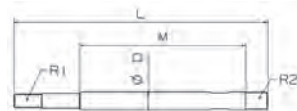

## 80 ALARGADERA · EXTENDERS · RALLONGES









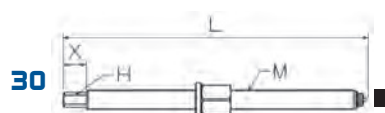

Ref.	L	R1	R2	M	Ø D		Tuerca de enlace 	Adaptadores 
110280 (*) 1102-150 **	158	3/8" - 24h	M-10	100	12	1102 1103	110217	M6-M8-M10 M12-M14-1/2"
111080 (*) 1110-180 1110-230 ** 1110-360 1110-460	180 230 360 460	5/8" - 18h 5/8" - 18h 5/8" - 18h 5/8" - 18h	1/2" - 20h 1/2" - 20h 1/2" - 20h 1/2" - 20h	100 150 280 380	16 16 16 16	1110	111017	M12-M14-M16 M18-M20
112080 (*) 1120-209 1120-336 ** 1120-515 1120-665 1120-855	209 336 515 665 855	5/8" - 18h 5/8" - 18h 5/8" - 18h 5/8" - 18h 5/8" - 18h	3/4" - 16h 3/4" - 16h 3/4" - 16h 3/4" - 16h 3/4" - 16h	89 216 395 545 735	25 25 25 25 25	1120 1128	112017	M12-M14-M16 M18-M20
113580 (*) 1130-328 1130-582 ** 1130-836	328 582 836	1" - 14h 1" - 14h 1" - 14h	1" - 14h 1" - 14h 1" - 14h	158 412 667	32 32 32	1135	113517	
115280 (*) 1152-504 1152-820 ** 1152-1076	504 820 1075,5	1 1/4" - 12h 1 1/4" - 12h 1 1/4" - 12h	1 1/4" - 12h 1 1/4" - 12h 1 1/4" - 12h	292 608,5 864	42 42 42	1152	115217	

80 Completa (\*): Incluye Brida (04) + Tuerca (08) Arandela (14) + Tuerca tope (13)  
 \*\* standar



## 03-30 HUSILLO · SPINDLE · VIS





Ref.	M	L	X	H		
110203	8 x 1	85	10	12		fijo 1102 / 1103
111030	12 x 1,25	140	20	14		fijo 1110
112030	12 x 1,25	165	20	14		fijo 1120-1128
113530	20 x 1,50	255	25	22		1135
115030	20 x 1,50	320	25	22		1150

# SERIE 1200

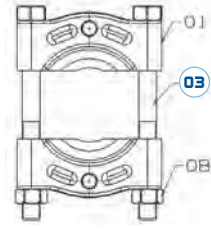

Guillotina  
Splitters  
Decolleur



Ref.	A max	A min	B	R	e		03+08 (2)	L x rosca
<b>1202A</b>	60	4	60	3/8"	1	0,75	120230	130x7/16" 20h
<b>1203A</b>	80	6	80	3/8"	2,5	1,3	120330	160x7/16" 20h
<b>1204B</b>	110	10	110	5/8"	2,5	2,75	120430	210x5/8" 18h
<b>1206B</b>	134	12	155	5/8"	2	5,7	120630	265x3/4" 16h
<b>1208B</b>	210	14	180	5/8"	2,5	12,5	120830	400x7/8" 14h
<b>1208C</b>	210	14	180	1"	2,5	12,5	120830	400x7/8" 14h
<b>1210C</b>	250	17	260	1"	4	28,5	121030	453x1 1/8" 12h
<b>1210D</b>	250	17	260	1 1/4"	4	28,5	121030	453x1 1/8" 12h
<b>1212D</b>	300	35	300	1 1/4"	4,5	43,5	121230	580x1 1/4" 12h
<b>1213D</b>	300	35	335	1 1/4"	6	86,5	121330	650x1 3/4" 12h

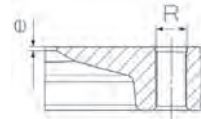
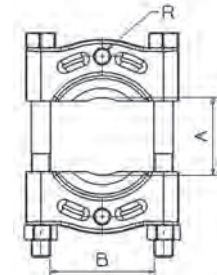

Ref.	A	B	C
<b>1102-1202A</b>	100	55	90
<b>1103-1203A</b>	100	80	130
<b>1110-1204B</b>	152	108	175
<b>1110-1206B</b>	152	77	182
<b>1120-1206B</b>	220	134	230
<b>1128-1206B</b>	220	210	290
<b>1128-1208B</b>	220	134	230
<b>1135-1208C</b>	418	210	285
<b>1135-1210C</b>	418	250	372
<b>1150-1210D</b>	617	250	362
<b>1150-1212D</b>	617	300	435
<b>1150-1213D</b>	617	300	450

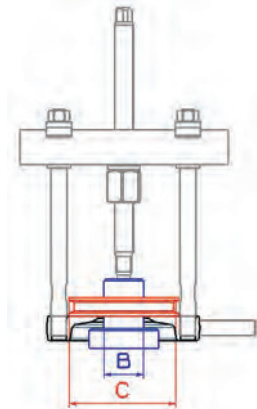

## ESTUCHE • PULLERS SET • COFFRET

Ref.	contenido / content / contenu	
<b>9082</b>	Puente 1102 + 2 patas 100250. Guillotina 1202A. Adaptadores roscados: M6-8-10-12-14-1/2"- 3/8"	2,80

Estuche de extractores con adaptadores roscados  
Pullers set with threaded adapters  
Coffret extraction avec des adaptateurs filetés





# SERIE 1100S



Extractor mecánico 2 alargaderas extensibles, SIMPLE

2 legs push puller with possible extension (Basic type)

Extracteur potence 2 bras avec rallonge possible (basique)

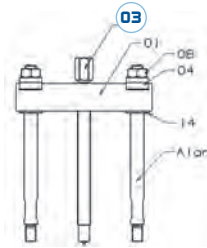

1102-1103

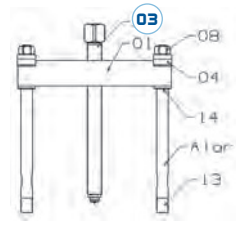

Resto de modelos

Ref.	A	B max	B min	C	TON.	
1102S	115	110	46	122	2	1
1103S	115	140	46	156	2	1
1110S	175	195	62	210	10	3
1115S	175	245	70	260	15	3,5
1120S	245	325	105	346	20	9,5
1128S	245	445	173	475	20	12

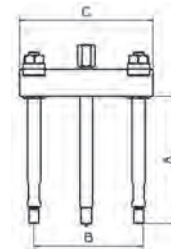

1102-1103

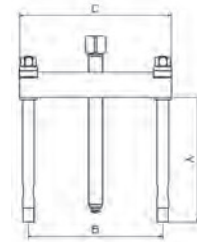

Resto de modelos

**03-31**

**HUSILLO · SPINDLE · VIS**



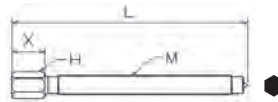

03

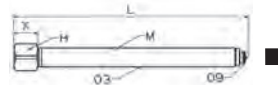

31



Ref.	M	L	X	H		
110203	12 x 1,25	167	20	14	● fijo	1102S / 1103S
101031	20 x 1,50	320	25	22	■ mww	1110S
131031	20 x 1,50	320	25	22	■ mww	1115S
131731	27 x 2	377	30	27	■ mww	1120S / 1128S

**CONJUNTOS · SETS · JEUX**

Ref.	contenido / content / contenu
C1102S	1102S + 2 patas 100250 + 1202A
C1103S	1103S + 2 patas 100260 + 1203A
C1110S	1110S + 2 patas 101050 + 1204B
C1115S	1115S + 2 patas 101060 + 1206B

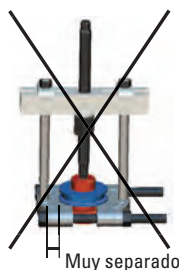

Muy separado

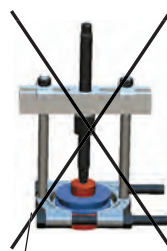

Guillotina invertida



La alargadera cerca de la pieza

Guillotina con la parte plana hacia la pieza

Sí  
Yes  
Oui

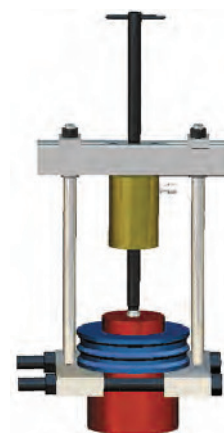

**SERIE 1100H**

**PARTE HIDRÁULICA · HYDRAULIC PART · PARTIE HYDRAULIQUE**

Ref.	Tn		
00904	4	1108HF-1108AHF	5,2
00910	10	1110H	11,0
00918	20	1118H	16,0
00930	30	1130H	19,0
00952	50	1152H	43,0

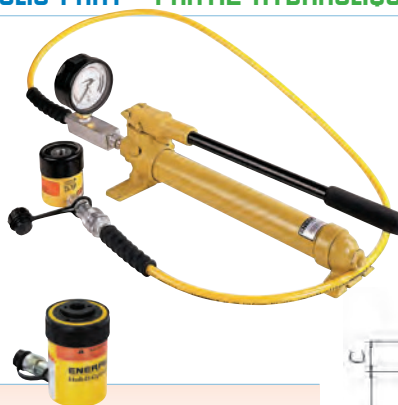

**CILINDRO · RAM · PISTON**

Ref.	Ø A	C	H	Tm	Ref. HUSILLO	R	Ø P	r	
09041	38	76	160	4	-	-	25,40	-	1,5
09101	70	25	81	10	111083	3/4" UNF 16h	35,10	5/16" UNC 18h	2,5
09181	99	48	160	20	111883	1" UNC 8h	54,10	3/8" UNC 16h	7,5
09301	114	63	178	30	113083	1 1/4" UNC 7h	63,50	3/8" UNC 16h	10,5
09521	159	75	235	50	115283	1 5/8" UNS 5,5h	91,90	1/2" UNC 13 h	31

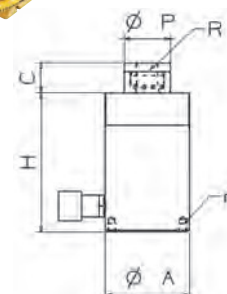

# SERIE 1108H

Extractor hidráulico 2 alargaderas extensibles  
 2 legs hydraulic push puller with possible extension  
 Extracteur hydraulique potence 2 bras avec rallonge possible

PM: Parte mecánica  
 PH: Parte hidráulica

## 8 TON

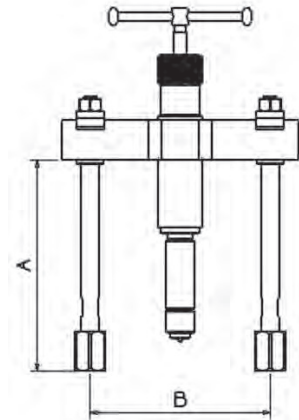
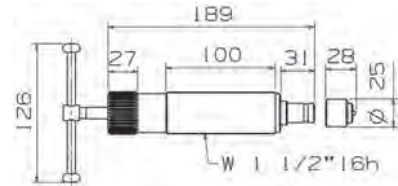
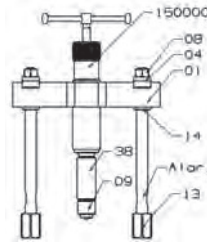

Ref. PM	A	B max	B min	Ref. PH	ALARGADERA	Tm	COMBINA CON	
<b>1108H</b>	190	200	82	<b>150000</b>	111080	8	1204B-1206B	4,4
<b>1108AH</b>	190	250	82	<b>150000</b>	111080	8	1204B-1206B	4,7

## 4 TON

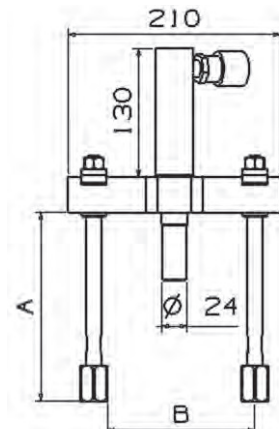
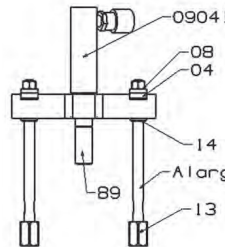
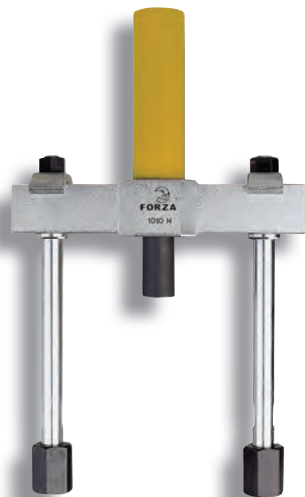

Ref. PM	A	B max	B min	Ref. PH	ALARGADERA	Tm	COMBINA CON	
<b>1108HF</b>	190	200	82	<b>00904</b>	111080	4	1204B-1206B	7,5
<b>1108AHF</b>	190	250	82	<b>00904</b>	111080	4	1204B-1206B	7,8

# SERIE 1100H



Extractor hidráulico 2 alargaderas extensibles

2 legs hydraulic push puller with possible extension

Extracteur hydraulique potence 2 bras avec rallonge possible

PM: Parte mecánica  
PH: Parte hidráulica

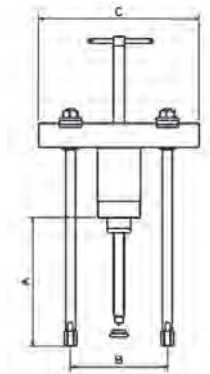
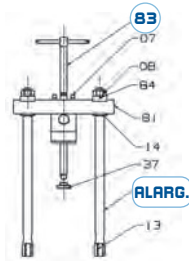





Ref. PM	A	B max	B min	C	Ref. PH	TON.	
<b>1110H</b>	300	260	115	280	<b>00910</b>	10	18,5
<b>1118H</b>	265	345	140	370	<b>00918</b>	20	34,5
<b>1130H</b>	284	440	180	480	<b>00930</b>	30	56
<b>1152H</b>	447	580	220	615	<b>00952</b>	50	113,5

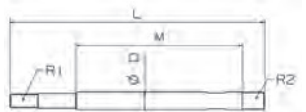

## 80 ALARGADERA · EXTENDER · RALLONGE





Ref.	L	R1	R2	M	Ø D		Tuerca de enlace 	Adaptadores 	Protector 
<b>1110-209H</b>	180	5/8" - 18h	1/2" - 20h	100	16	1110H	112017	M12-M14-M16 M18-M20	111037
<b>1110-460H(*)</b>	230	5/8" - 18h	1/2" - 20h	150	16				
<b>1110-540H</b>	360	5/8" - 18h	1/2" - 20h	280	16				
<b>1120-209</b>	209	5/8" - 18h	3/4" - 16h	89	25	1118H	112017	M12-M14-M16 M18-M20	111837
<b>1120-336</b>	336	5/8" - 18h	3/4" - 16h	216	25				
<b>1120-515(*)</b>	515	5/8" - 18h	3/4" - 16h	395	25				
<b>1120-665</b>	665	5/8" - 18h	3/4" - 16h	545	25				
<b>1120-855</b>	855	5/8" - 18h	3/4" - 16h	735	25				
<b>1130-328</b>	328	1" - 14h	1" - 14h	158	32	1130H	113517		113037
<b>1130-582 *</b>	582	1" - 14h	1" - 14h	412	32				
<b>1130-836</b>	836	1" - 14h	1" - 14h	667	32				
<b>1152-504</b>	504	1 1/4" - 12h	1 1/4" - 12h	292	42	1152H	150017		113037
<b>1152-820 (*)</b>	820	1 1/4" - 12h	1 1/4" - 12h	608,5	42				
<b>1152-1076</b>	1075,5	1 1/4" - 12h	1 1/4" - 12h	864	42				

(\*) = Estandar

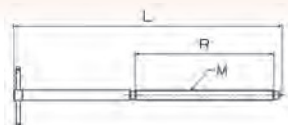
## 83 HUSILLO · SPINDLE · VIS



Ref.	M	L	Cabeza			R
<b>111083</b>	3/4" UNF 16h	400	manilla	fijo	1110H	222
<b>111883</b>	1" UNC 8h	670	manilla	fijo	1118H	348
<b>113083</b>	1 1/4" UNC 7h	790	manilla	fijo	1130H	427
<b>115283</b>	1 5/8" UNS5,5h	975	manilla	fijo	1152H	530

# SERIE 1500H



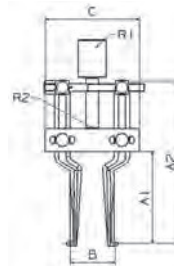

Extractor de interiores  
Interior puller  
Extracteur d'intérieur

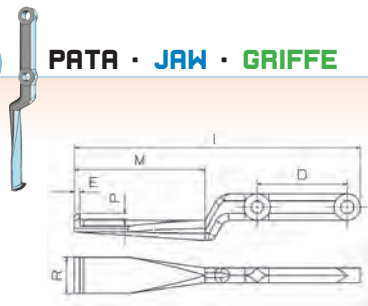

Ref.	A1	A2	B max	B min	C	R1 rosca pomo	R1 rosca cuerpo	COMBINA CON	
1506H10	115	237	145	40	133	3/4" UNF16h	5/8" 14h	1110H	2,0
1506H20	115	237	145	40	133	1" UNF 8h	5/8" 14h	1118H	2,4
1507H10	140	266	160	32	133	3/4 UNF 16h	5/8" 14h	1110H	2,1
1507H20	140	266	160	32	133	1" UNF 8h	5/8" 14h	1118H	2,4
1509H30	150	310	240	60	202	1 1/4 UNF 7h	1" 14h	1130H	6,0
1509H50	150	310	240	60	202	1 5/8 UNS 5,5h	1" 14h	1152H	6,4

**05** PATA · JAW · GRIFFE



Ref.	P	R	E	M	L	D	
150605	4,5	31	5	115	240	74,5	1506H
150705	4,5	25	4,5	140	266	74,5	1507H
150905	11	55	8	150	311	115	1509H



## SERIE 1200

Guillotina  
Splitters  
Decolleur  
Elección guillotina  
Splitter selection  
Sélectionner le décolleur

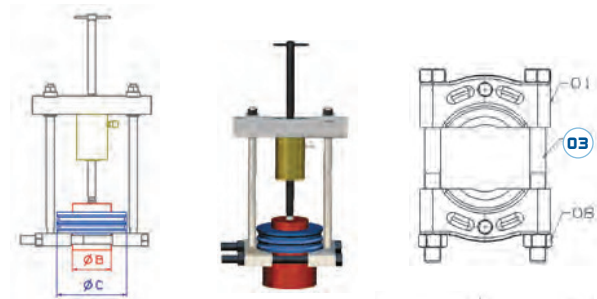

Ref.	A max	A min	B	R	e	C	COMBINA CON		03+08 (2)	L	R
1204B	110	10	110	5/8"	2,5	175	1110H-1108H	2,75	120430	210	5/8" 18h
1206B	134	12	155	5/8"	2	182	1110H-1108H-1108H	5,7	120630	265	3/4" 16h
1208B	210	14	180	5/8"	2,5	290	1108H-1108AH	12,5	120830	400	7/8" 14h
1208C	210	14	180	1"	2,5	285	1130H	12,5	120830	400	7/8" 14h
1210C	250	17	260	1"	4	372	1130H	28,5	121030	453	1 1/8" 12h
1210D	250	17	260	1 1/4"	4	362	1152H	28,5	121030	453	1 1/8" 12h
1212D	300	35	300	1 1/4"	4,5	435	1152H	43,5	121230	580	1 1/4" 12h
1213D	300	35	335	1 1/4"	6	450	1152H	86,5	121330	650	1 3/4" 12h

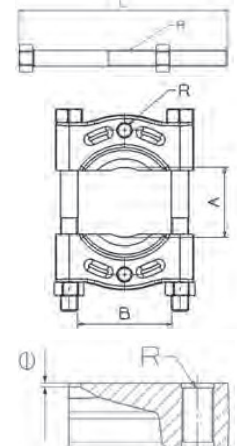

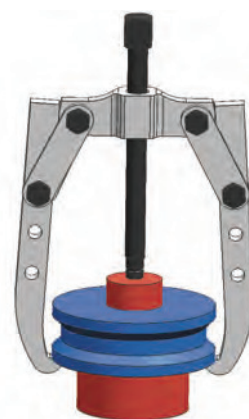

**SERIE 1300**



**SERIE 1300T**

combinado  
2/3 patas

Extractor mecánico 2/3 patas  
oscilantes

3 jaws manual puller

Extracteur à 3 griffes



**SERIE 1300AT**

Autocentrantes

Self centering 2/3 jaws pullers

Extracteur autocentrant 2/3 griffes



# SERIE 1300



Extractor mecánico 2 patas oscilantes, exterior  
 2 and 3 jaws puller  
 Extracteur à 2 et 3 griffes

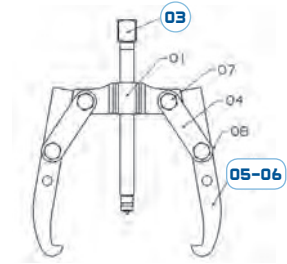

Ref.	A	B	C	TON.	
1300	55	70	37	0,5	0,2
1301	85	100	70	1	0,4
1304	135	150	76	4	1,2
1307	180	200	113	7	2,3
1310	300	310	161	10	5,5
1317	365	425	280	17	11,5
1330	460	520	325	30	25,5
1350	750	850	402	50	49

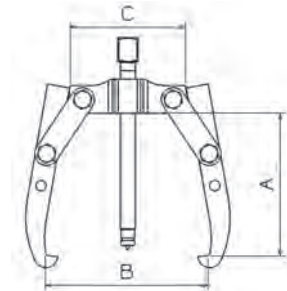
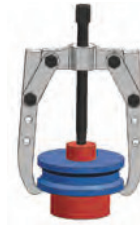

## SERIE 1300L



Ref.	A	B	C	TON.	
1300L	70	90	37	0,5	0,2
1301L	105	110	70	1	0,5
1304L	185	175	76	4	1,4
1307L	225	240	113,5	7	2,5
1310L	385	360	161	10	6
1317L	480	480	280	17	13
1330L	585	580	325	30	30

L: Pata larga - Long jaw - Griffe longue

# SERIE 9300



Extractor mecánico 2 patas oscilantes  
 2 jaws puller  
 Extracteur à 2 griffes

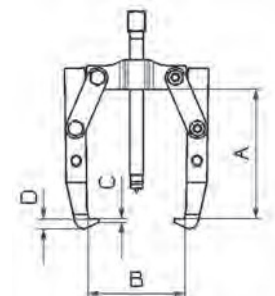

Ref.	A	B	C	D	TON.	
9300	55	70	1,5	4,5	0,5	0,2
9301	85	100	2,5	6	1	0,5

# SERIE 1300T

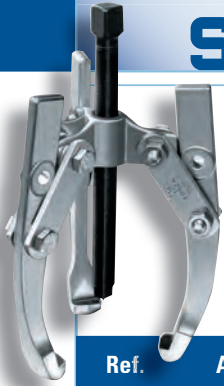

Extractor mecánico 2/3 patas oscilantes  
2 and 3 jaws puller  
Extracteur à 2 et 3 griffes

Ref.	A	B		C	TON.	
1300T	55	70	no	37	0,5	0,3
1301T	85	100	si	70	1	0,7
1304T	135	150	si	76	4	1,8
1307T	180	200	si	108	7	3,3
1310T	300	310	si	161	10	7,5
1317T	365	425	no	280	17	16,5
1330T	460	520	no	325	30	33,5
1350T	750	850	no	402	50	65

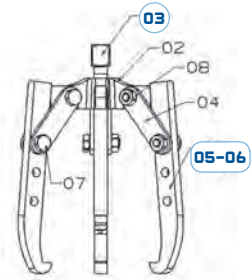

# SERIE 1300LT

Ref.	A	B		C	TON.	
1300LT	70	90	no	47	0,5	0,3
1301LT	105	110	si	70	1	0,7
1304LT	185	175	si	76	4	2,1
1307LT	225	240	si	108	7	3,5
1310LT	385	360	si	161	10	8,5
1317LT	480	480	no	280	17	18,5
1330LT	585	580	no	325	30	39

T: 3 patas · 3 jaws · 3 griffes  
L: Pata larga · Long jaw · Griffes longue

  
combina  
2/3 patas

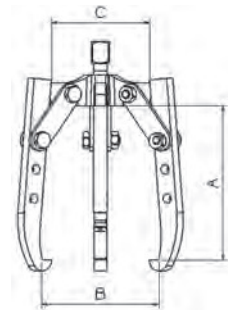

# SERIE 9300T



Extractor mecánico 3 patas oscilantes  
3 jaws puller  
Extracteur à 3 griffes

Ref.	A	B		C	D	TON.	
9300T	55	70	no	1,5	4,5	0,5	0,3
9301T	85	100	si	2,5	6	1	0,7

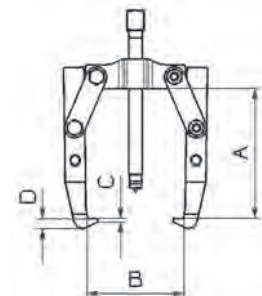



# CONJUNTOS / SET / JEUX

Estuche pequeños extractores

Small pullers set

Coffret petits extracteurs

## 1 TN

Ref.	se puede componer / can be composed / peut être composé	
9300K	9300 - 9300T - 9301 - 9301T	1,8



## 4 TN KIT COMBI

Ref.	se puede componer / can be composed / peut être composé	
9084	1002 - 1102 - 1202A - 5010 - 1304 - 1304T - 1404 - 1404T	6,5

## 7 TN KIT COMBI

Ref.	se puede componer / can be composed / peut être composé	
9087	1010 - 1110 - 1204B - 1307 - 1307L - 1307LT - 1407 - 1407T - 2301 - 2302	14,5





**SERIE 1300H**



**PARTE HIDRÁULICA · HYDRAULIC PART · PARTIE HYDRAULIQUE**

Ref. PH	Tn		
00904	4	1307ALT	5,2
00910	10	1310TH-1310THA	11
00918	20	1318H-1318TH-1318THA	16
00930	30	1330H-1330TH-1330THA	19
00952	50	1352H-1352TH-1352THA	43



**CILINDRO · RAM · PISTON**

Ref.	Ø A	C	H	Tm	Ref. HUSILLO	R	Ø P	r	
09041	38	76	178	4	-	-	25,4	-	1,5
09101	70	25	81	10	111083	3/4" UNF 16h	35,1	5/16" UNC 18h	2,5
09181	99	48	160	20	111883	1" UNC 8h	54,1	3/8" UNC 16h	7,5
09301	114	63	178	30	113083	1 1/4" UNC 7h	63,5	3/8" UNC 16h	10,5
09521	159	75	235	50	115283	1 5/8" UNS 5,5h	91,9	1/2" UNC 13 h	31

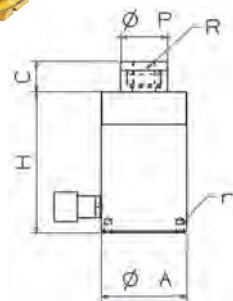

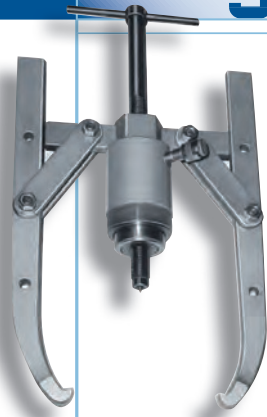

# SERIE 1300H

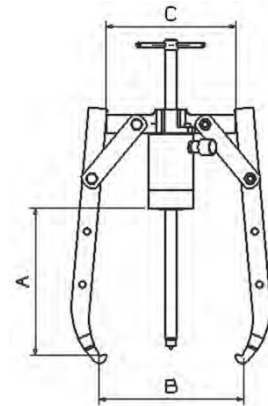
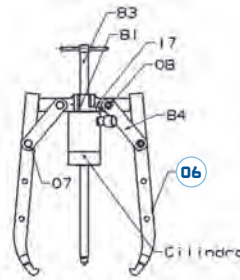

Extractor hidráulico 2 patas oscilantes, exterior  
 2 jaws hydraulic puller  
 Extracteur à 2 griffes hydraulique

PM: Parte mecánica  
 PH: Parte hidráulica



Ref. PM	A	B max	B min	C	Ref. PH	TON.	
<b>1318H</b>	320	480	70	280	<b>00918</b>	20	34
<b>1330H</b>	407	580	90	325	<b>00930</b>	30	49
<b>1352H</b>	727	920	120	414	<b>00952</b>	50	109

# SERIE 1300TH

Extractor hidráulico 3 patas oscilantes  
 3 jaws hydraulic puller  
 Extracteur à 3 griffes hydraulique

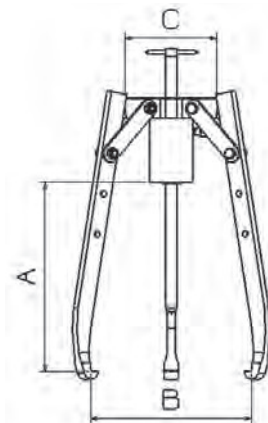
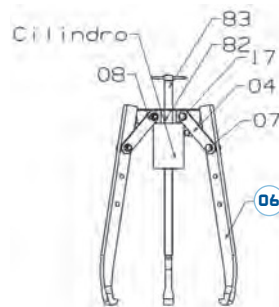
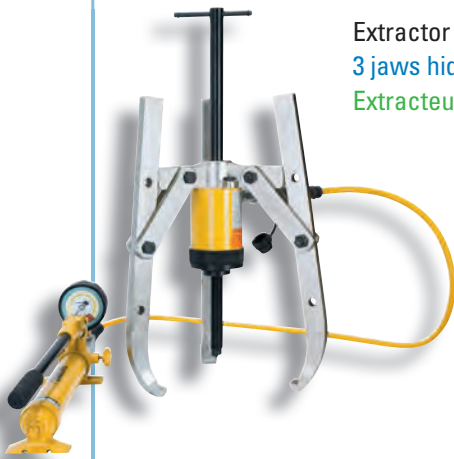

Ref. PM	A	B max	B min	C	Ref. PH	TON.	
<b>1310TH*</b>	296	350	50	176	<b>00910</b>	10	20
<b>1318TH</b>	320	480	70	277	<b>00918</b>	20	39
<b>1330TH</b>	407	580	90	322	<b>00930</b>	30	59
<b>1352TH</b>	750	1080	120	414	<b>00952</b>	50	130

(\*): 1310TH 2 y 3 patas · 1310TH 2 and 3 jaws · 1310TH 2 et 3 griffes

# SERIE 1300HC

Compactos  
Hydraulic 3 jaws pullers  
Extracteur hydraulique à 3 griffes

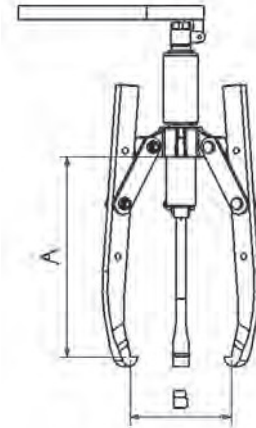
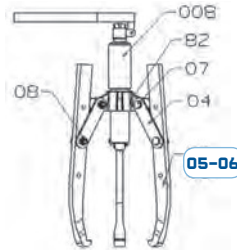

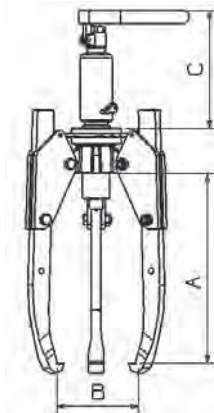
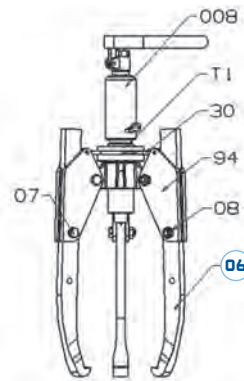
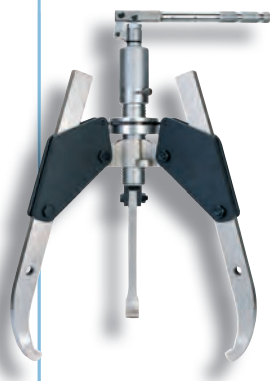

Ref.	A	B <sub>max</sub>	B <sub>min</sub>	TON.	
<b>1306CTH</b>	300	310	50	6	10,2
<b>1306CLTH</b>	385	360	50	6	11,2
<b>1308CTH</b>	365	425	70	8	19,5
<b>1308CLTH</b>	480	480	70	8	21,5



Ref.	A	B <sub>max</sub>	B <sub>min</sub>	C	TON.	
<b>1306CTA</b>	300	310	50	220	6	10,2
<b>1306CLTA</b>	385	360	50	220	6	11,2
<b>1308CTA</b>	365	425	70	205	8	19,5
<b>1308CLTA</b>	480	480	70	205	8	21,5

## COMPACTOS BOMBA Y CILINDRO INTEGRADOS

Ref.	CARRERA stroke		CILINDRO ram/piston	TON	
<b>00806</b>	62	1306CTH-1306CLTH-1306CTA-1306CLTA	integrado	6	3,1
<b>00808</b>	82	1308CTH-1308CLTH-1308CTA-1308CLTA	integrado	8	3,8

Ref.	TON	A	B	ØC	D	E	ØF	ØG	ØH
<b>00806</b>	6	340	310	23	120	115	22	45	54
<b>00808</b>	8	360	310	23	155	115	22	50	60

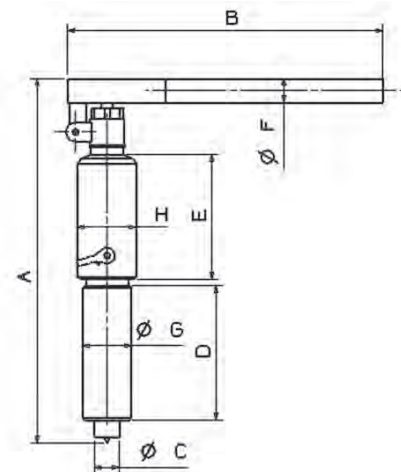

# CONJUNTOS

Conjuntos hidráulicos

Hydraulic pullers set

Jeux d'extracteur hydraulique

PM: Parte mecánica

PH: Parte hidráulica

## TIPO K

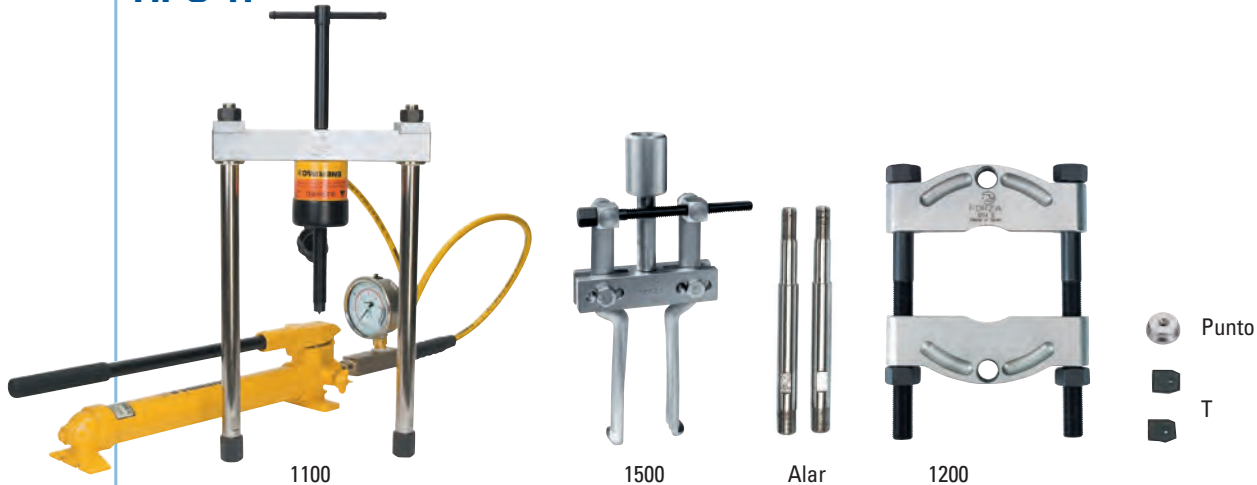

Ref. PM	Ref. PH	Ton	1100 1x	1200 1x	1500H 1x	Punto 1x	T 2x	Alarg. Standard	Alarg. Extra	⚖️
<b>K0-10</b>	<b>00910</b>	10	1110H	1204B	1506H10	111037	111017	1110-460H	1110-209H	27
<b>K1-18</b>	<b>00918</b>	20	1118H	1206B	1506H20	111837	112017	1120-515	1120-209	38
<b>K2-30</b>	<b>00930</b>	30	1130H	1210C	1509H30	113037	113517	1130-582	1130-328	80
<b>K3-45</b>	<b>00952</b>	50	1152H	1210D	1509H50	113037	115017	1152-820	1152-504	128
<b>K3-50</b>	<b>00952</b>	50	1152H	1212D	1509H50	113037	115017	1152-820	1152-504	143

## TIPO C

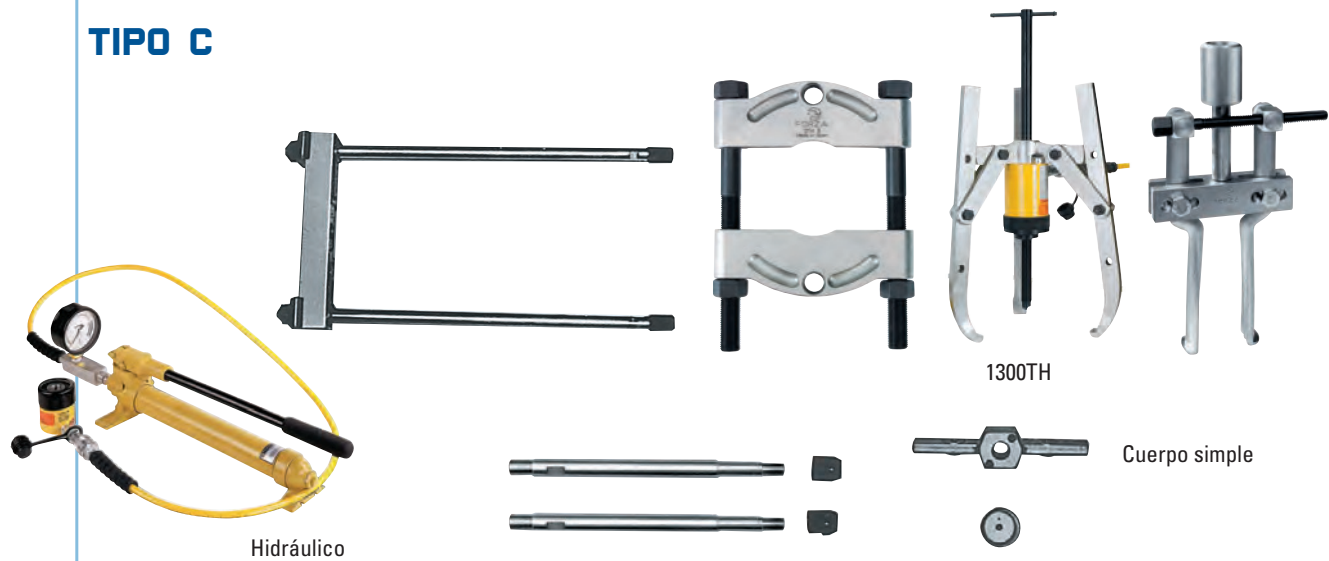

Ref. PM	Ref. PH	Ton	1100 1x	1200 1x	1500H 1x	Punto 1x	T 2x	Alarg. Standard	Alarg. Extra	1300TH 1x	Cuerpo 1x	⚖️
<b>C0-10</b>	<b>00910</b>	10	1110H	1204B	1506H10	111037	111017	1110-460H	1110-209H	1310TH		35
<b>C1-18</b>	<b>00918</b>	20	1118H	1206B	1506H20	111837	112017	1120-515	1120-209	1318TH	131881	60
<b>C2-30</b>	<b>00930</b>	30	1130H	1210C	1509H30	113037	113517	1130-582	1130-328	1330TH	133081	120
<b>C3-45</b>	<b>00952</b>	50	1152H	1210D	1509H50	113037	115017	1152-820	1152-504	1352TH	135281	215
<b>C3-50</b>	<b>00952</b>	50	1152H	1212D	1509H50	113037	115017	1152-820	1152-504	1352TH	135281	230
<b>C3-52</b>	<b>00952</b>	50	1152H	1213D	1509H50	113037	115017	1152-820	1152-504	1352TH	135281	270



## 8 TON



Extractor hidráulico 8 TON

Hydraulic puller 8 TON

Extracteur hydraulique de 8 Tonnes

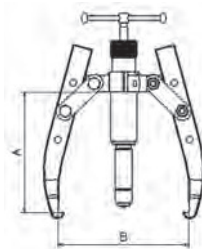
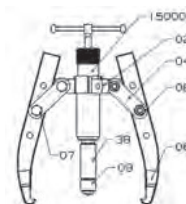

Ref.	A	B	
1308TH	225	240	4

### CONJUNTOS · SETS · JEUX

Ref.	se puede componer / can be composed / peut être composé	
C1004	1010H / 1108H / 1204B / 1010LH alargaderas	11,3
C1005	1010H / 1108H / 1204B / 1010LH alargaderas / 1308TH	14,5
C1006	1010 AH / 1010 LAH / 1206 B / 1108 AH alargaderas	15

C-1004 · C-1006

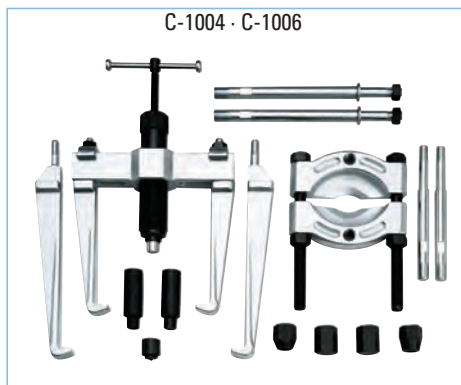

C-1005



### SE PUEDEN COMPONER

C-1005

C-1004 · C-1006

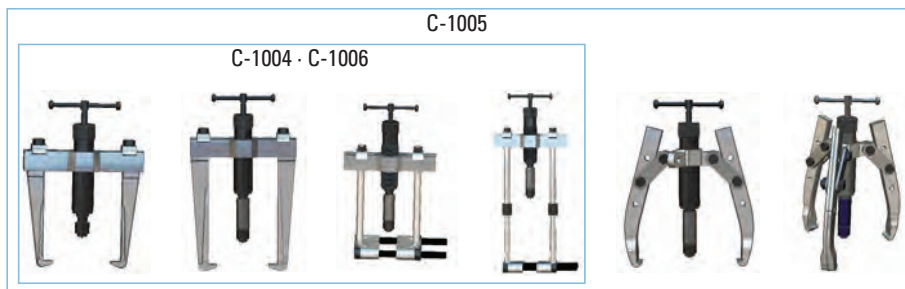

# 4 TON

Extractor hidráulico 4 TON  
 Hydraulic puller 4 TON  
 Extracteur hydraulique de 4 Tonnes

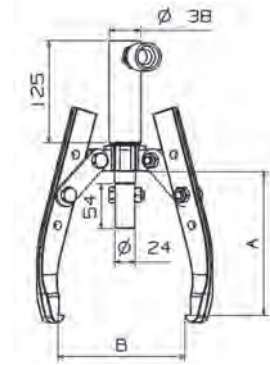

Ref. PM	Ref. PH	A	B	
1307LTH	00904	225	240	4

## C1008

Conjunto hidráulico 8 TON  
 8 TON hydraulic puller set  
 Jeux d'extracteur hydraulique 8 Tonnes



00904

### CONJUNTOS · SETS · JEUX

Ref. PM	Ref. PH	contenido / content / conten
C1008	00904	1-00904 1-1110HF 1-1307HPM 1-1204B 2-101060 2-1110-180



1110 HF

1204B



1307HPM



101060



1110-180



## SERIE 1300AT

Autocentrantes  
Self centering 2/3 jaws pullers  
Extracteur autocentrant 2/3 griffes

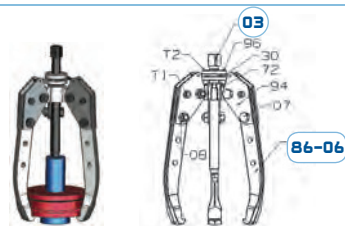

Ref.	A	B	B min	↕	C	TON.	⚖
1301ALT	105	110	15	si	79,5	1	1
1304ALT	185	175	25	si	104	4	2,5
1307ALT	225	240	40	si	108	7	6,5
1310ALT	385	360	50	si	176	10	14,5
1317ALT	480	480	70	no	276	17	31,5
1330ALT	585	580	90	no	322	30	55,5

A: Autocentrante  
L: Pata larga · Long jaw · Griffe longue  
T: 3 patas · 3 jaws · 3 griffes

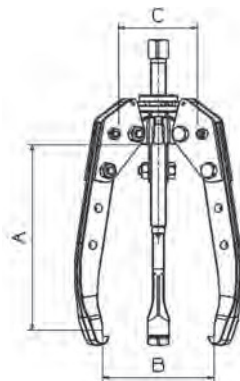

### EXPOSITOR · MERCHANDISER · PRÉSENTOIR

Ref.	composición	⚖
1300A	1301 ALT-1304ALT-1307ALT	13



03  
31

### HUSILLO · SPINDLE · VIS

### MECÁNICO

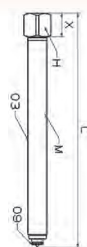

Ref.	M	L	X	H	🛡	⚖
130003	8 x 1	90	12	9	fijo	1300 / 1300T
130103	10 x 1	124	14	12	fijo	1301 / 1301T / 1301L / 1301LT / 1301ALT
130403	14 x 1,50	177	20	16	fijo	1304 / 1304T / 1304L / 1304LT / 1304ALT
130703	18 x 1,50	235	24	19	fijo	1307 / 1307T / 1307L / 1307LT / 1307ALT
131032	20 x 1,50	321	25	22	🌀	1310 / 1310T / 1310L / 1310LT / 1310ALT
131731	27 x 2	377	30	27	🌀	1317 / 1317T / 1317L / 1317LT / 1317ALT
133031	1 3/8" 12h.	510	38	35	🌀	1330 / 1330T / 1330L / 1330LT / 1330ALT
135231	1 3/8" 12h.	535	38	35	🌀	1352 / 1352T

Husillo 31 = Husillo (03) + Punto (09)

83

### HUSILLO · SPINDLE · VIS

### HIDRÁULICO

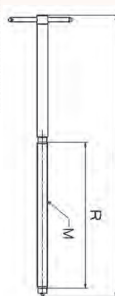

Ref.	M	L	Cabeza	🛡	⚖	R
111083	3/4" UNF 16h	400	manilla	fijo	1310H-1310TH-1310THA	222
111883	1" UNC 8h	670	manilla	fijo	1318H-1318TH-1318THA	348
113083	1 1/4" UNC 7h	790	manilla	fijo	1330H-1330TH-1330THA	427
115283	1 5/8" UNS 5,5h	975	manilla	fijo	1352H-1352TH-1352THA	530



# SERIE 1300THA

Extractor hidráulico 3 patas autocentrante  
 Self centering 3 jaws hydraulic puller  
 Extracteur hydraulique autocentrant 3 griffes

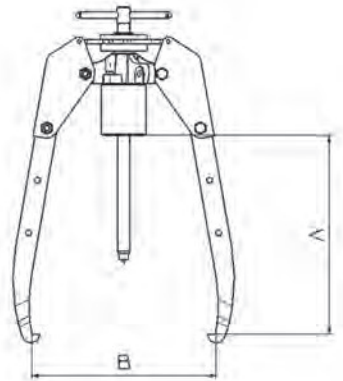
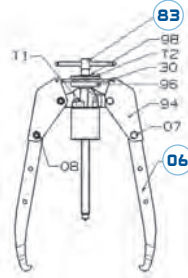

Ref.	A	B max	B min	TON.	
1310THA*	296	350	50	10	25,5
1318THA	320	480	70	20	49
1330THA	407	580	90	30	75,5
1352THA	750	1080	120	50	177

(\*): 1310TH 2 y 3 patas · 1310TH 2 and 3 jaws · 1310TH 2 et 3 griffes

A: Autocentrante  
 H: Hidráulico  
 T: 3 patas · 3 jaws · 3 griffes

**05-06**  
**-86**



## PATA · JAW · GRIFFE

05: Corta · Short · Courte  
 06: Larga · Long · Longue

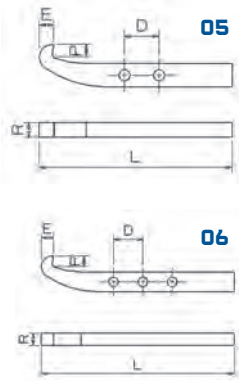

Ref.	P	R	E	L	D	
130005	4,5	6,5	5	70	13	1300 / 1300T
130006	4,5	6,5	5	85	13	1300L / 1300LT
130105	6,5	8	7	106	19	1301 / 1301T
130106	7	7,5	8	127	19	1301L / 1301LT
130186	7	7,5	8	127	19	1301ALT
130405	7	21	7	166	51	1304 / 1304T
130406	8	21	7,5	219	51	1304L / 1304LT
130486	8	21	7,5	219	51	1304ALT
130705	8,5	25	9	217	44,5	1307 / 1307T
130706	8	25	10	264	44,5	1307L / 1307LT
130786	8	25	10	264	44,5	1307ALT
131005	15	25	12,5	355	83	1310 / 1310T
131006	15	25	12,5	436	83	1310L / 1310LT / 1310ALT
131705	15,5	32	16	435	115	1317 / 1317T
131706	17,5	31	15,5	550	115	1317L / 1317LT / 1317ALT
133005	23	42	22	557	125	1330 / 1330T
133006	24	41	22	698	125	1330L / 1330LT
135205	31	50	30	1065	150	1350 / 1350T



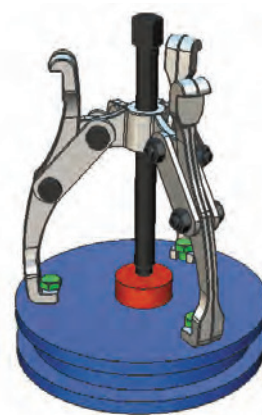

**SERIE 1400LT**

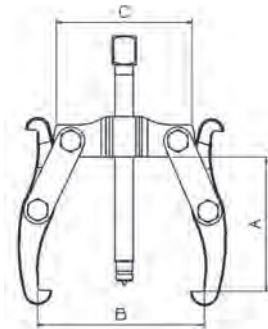
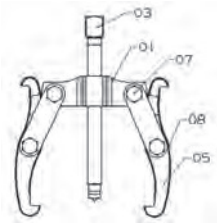

# SERIE 1400

Extractor mecánico 2 patas reversibles  
 2 jaws reversible puller  
 Extracteur 2 griffes reversibles



Ref.	A	B	C	TON.	
1401	65	100	70	1	0,3
1404	85	135	76	4	1
1407	125	200	113	7	2,1
1410	260	320	161	10	4,5

# SERIE 1400L



Ref.	A	B	C	TON.	
1401L	85	120	70	1	0,5
1404L	135	160	76	4	1,2
1407L	180	225	113	7	2,7

L: Pata larga · Long jaw · Griffes longue

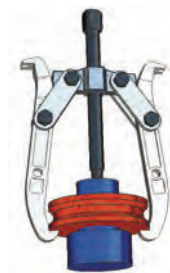
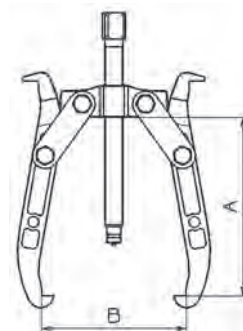

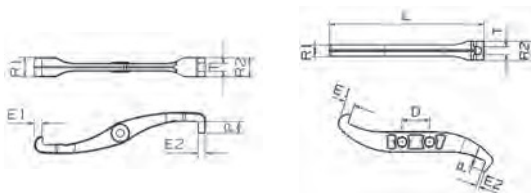

**05-06** **PATA · JAW · GRIFFE**  
 05: Corta · Short · Courte  
 06: Larga · Long · Longue

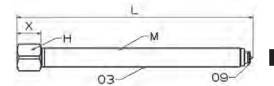

**03** **HUSILLO · SPINDLE · VIS**  
**31** 09: Punto · Point · Point



Ref.	P	P	R1	R2	E1	E2	L	D	T	
140105	6	5	6,7	14	7	6	93	no	no	1401 / 1401T
140405	9	6,5	8	18	10	8	126	no	no	1404 / 1404T
140705	11	9,5	25	25	11	9,5	211	no	10,5	1407 / 1407T
141005	15,5	20	25,8	27	12,5	14,2	300	50	12	1410 / 1410T
140106	6	7	8	13	7	3	110	19	5	1401L / 1401LT
140406	9,5	11,5	10	17	10	6	178	51	6	1404L / 1404LT
140706	11	15	13	25	11	4	260	44,5	8	1407L / 1407LT

Ref.	M	L	X	H		
130103	10 x 1	124	14,5	12	■ fijo	1401 / 1401T / 1401L / 1401LT
130403	14 x 1,50	180	20,5	16	■ fijo	1404 / 1404T / 1404L / 1404LT
130703	18 x 1,50	250	24	19	■ fijo	1407 / 1407T / 1407L / 1407LT
131031	20 x 1,50	330	25	22	■ www	1410 / 1410T / 1410L / 1410LT

Husillo 31 = Husillo (03) + Punto (09)

# SERIE 1400T



Extractor mecánico 2 y 3 patas reversibles  
 2 and 3 jaws reversible puller  
 Extracteur 2 et 3 griffes reversibles

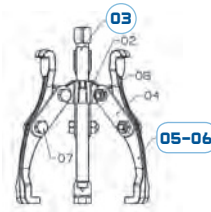

  
 combina  
 2/3 patas

Ref.	A	B		C	TON.	
1401T	65	80	si	80	1	0,3
1404T	85	150	si	106	4	1
1407T	125	200	si	109	7	2,1
1410T	260	320	si	176	10	4,5

T: 3 patas · 3 jaws · 3 griffes

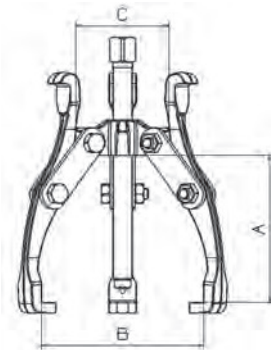

# SERIE 1400LT



Extractor mecánico 2 y 3 patas reversibles  
 2 and 3 jaws reversible puller  
 Extracteur 2 et 3 griffes reversibles

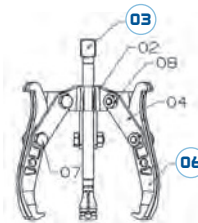

  
 combina  
 2/3 patas

Ref.	A	B		C	TON.	
1401LT	85	130	si	80	1	0,6
1404LT	135	180	si	106	4	1,2
1407LT	180	235	si	109	7	3,8

L: Pata larga · long jaw · griffe longue  
 T: 3 patas · 3 jaws · 3 griffes

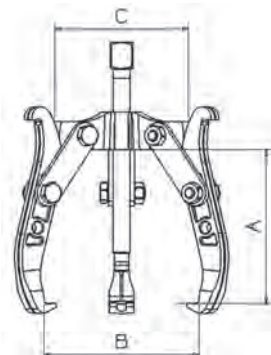

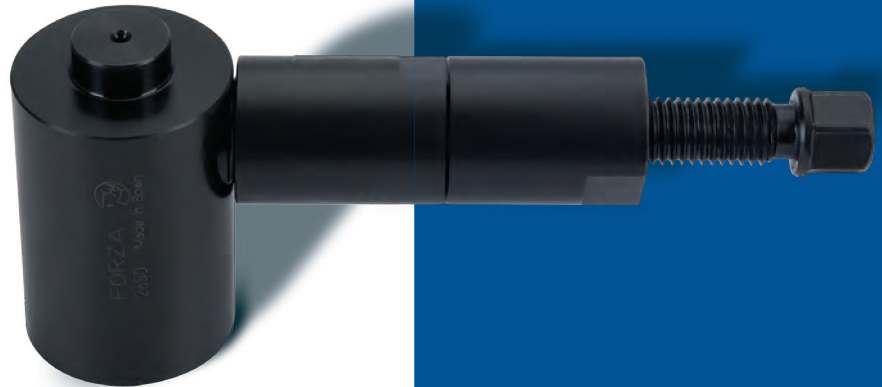

Ref.	ØA	ØB	ØC	D	E	F	G	Carrera	TON.	
2650	45	25	20	73	8	170	103	5	5	1,3
2655	70	25	28	82	12	170	103	5	11	2,4

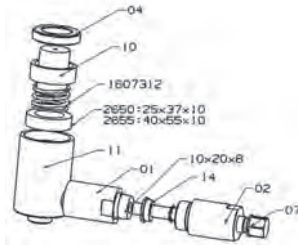
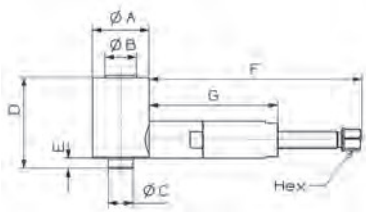

EXTRACTOR DE PASADORES ROSCADOS · THREADED PIN EXTRACTOR ·  
EXTRACTEUR DE BROCHES FILETÉES



CONJUNTO · SET · JEU

Ref.	
1950	Completo / Full set / Jeu complet 1,5

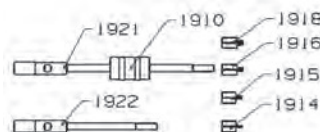
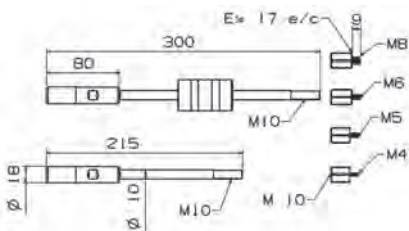



**SERIE 7300**

**7301LT**



**7301ALT**

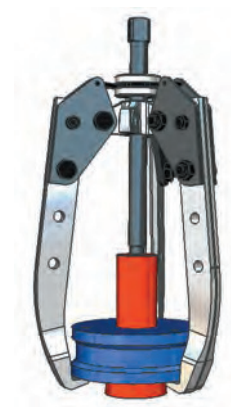

# SERIE 7300

Extractor mecánico 2 patas oscilantes, exterior  
 2 jaws puller  
 Extracteur à 2 griffes

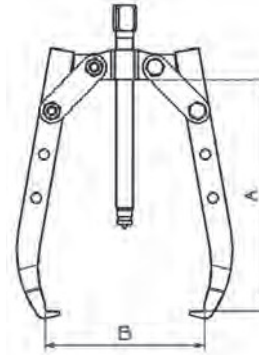
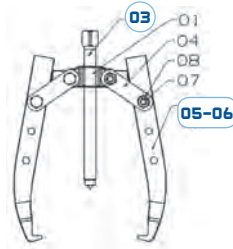
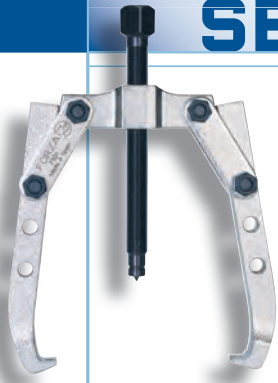

Ref.	A	B	Ref. pata	
<b>7301</b>	105	110	730105	0,4
<b>7304</b>	185	175	730405	1,3
<b>7307</b>	225	240	730705	2,8

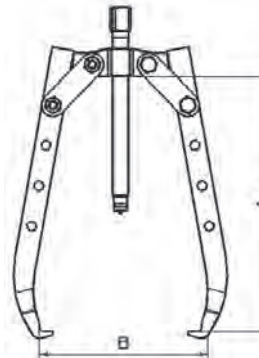
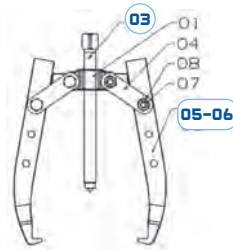
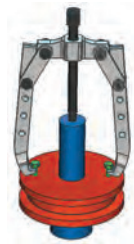
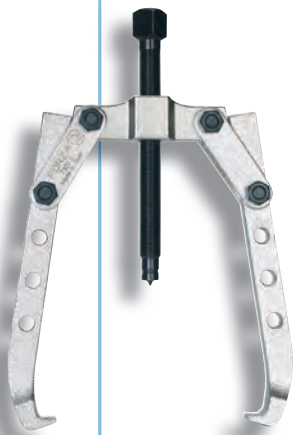

Ref.	A	B	Ref. pata	
<b>7301L</b>	120	125	730106	0,5
<b>7304L</b>	210	220	730406	1,4
<b>7307L</b>	270	280	730706	3,0

L: Pata larga · long jaw · griffe longue



# SERIE 7300T



Extractor mecánico 2 y 3 patas oscilantes, exterior

2 and 3 jaws puller



Extracteur à 2 et 3 griffes

Ref.	A	B	Ref. pata	 combina 2/3 patas	 peso
<b>7301T</b>	105	110	730105	si	0,7
<b>7304T</b>	185	175	730405	si	1,9
<b>7307T</b>	225	240	730705	si	3,5

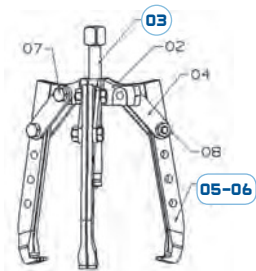
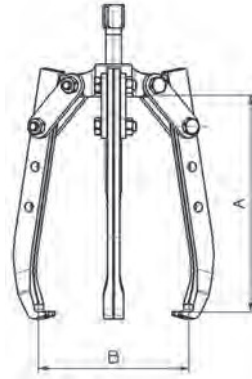
T: 3 patas - 3 jaws - 3 griffes



## SERIE 7300LT

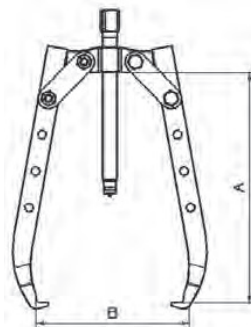

Ref.	A	B	Ref. pata	 combina 2/3 patas	 peso
<b>7301LT</b>	120	125	730106	si	0,7
<b>7304LT</b>	210	220	730406	si	2,1
<b>7307LT</b>	270	280	730706	si	3,7

L: Pata larga - long jaw - griffe lonngue



**03**

**HUSILLO · SPINDLE · VIS**

Ref.	M	L	X	H		
<b>130103</b>	10 x 1	124	14	12	fijo	7301-7301L-7301LT-7301AT-7301ALT
<b>130403</b>	14 x 1,50	177	20	16	fijo	7304-7304L-7304LT-7304AT-7304ALT
<b>130703</b>	18 x 1,50	235	24	19	fijo	7307-7307L-7307LT-7307AT-7307ALT







# Suministros Industriales del Tajo, S.A.

C/ Jarama 52, Polígono Industrial, 45007 Toledo (Spain)

Telf: (34) 925 23 22 00

Fax: (34) 925 23 21 47

[sitasa@sitasa.com](mailto:sitasa@sitasa.com)

[www.sitasa.com](http://www.sitasa.com)

